

# DLCERA

## SERVICE MANUAL

### Outdoor Unit Single Zone Ductless System – Sizes 09 to 24

#### TABLE OF CONTENTS

	PAGE
SAFETY CONSIDERATIONS .....	1
INTRODUCTION .....	1
MODEL/SERIAL NUMBER NOMENCLATURES .....	2
SPECIFICATIONS .....	3
DIMENSIONS .....	5
CLEARANCES .....	8
ELECTRICAL DATA .....	9
WIRING .....	9
CONNECTION DIAGRAMS .....	10
WIRING DIAGRAM .....	10
REFRIGERATION CYCLE DIAGRAMS .....	14
REFRIGERANT LINES .....	15
SYSTEM EVACUATION AND CHARGING .....	16
ELECTRONIC FUNCTIONS .....	17
TROUBLESHOOTING .....	21
OUTDOOR UNIT DIAGNOSTIC GUIDES .....	22
PCB DIAGRAMS .....	23
DIAGNOSIS AND SOLUTION .....	25
DISASSEMBLY INSTRUCTIONS .....	46
APPENDIX .....	69

#### SAFETY CONSIDERATIONS


Installing, starting up, and servicing air-conditioning equipment can be hazardous due to system pressures, electrical components, and equipment location (roofs, elevated structures, etc.).

Only trained, qualified installers and service mechanics should install, start-up, and service this equipment.


Untrained personnel can perform basic maintenance functions such as cleaning coils. All other operations should be performed by trained service personnel.

When working on the equipment, observe precautions in the literature and on tags, stickers, and labels attached to the equipment.

Follow all safety codes. Wear safety glasses and work gloves. Keep quenching cloth and fire extinguisher nearby when brazing. Use care in handling, rigging, and setting bulky equipment.

Read this manual thoroughly and follow all warnings or cautions included in literature and attached to the unit. Consult local building codes and National Electrical Code (NEC) for special requirements. Recognize safety information. This is the safety-alert symbol . When you see this symbol on the unit and in instructions or manuals, be alert to the potential for personal injury. Understand these signal words: **DANGER**, **WARNING**, and **CAUTION**.


These words are used with the safety-alert symbol. **DANGER** identifies the most serious hazards which **will** result in severe personal injury or death. **WARNING** signifies hazards which **could** result in personal injury or death. **CAUTION** is used to identify unsafe practices which **may** result in minor personal injury or product and property damage. **NOTE** is used to highlight suggestions which **will** result in enhanced installation, reliability, or operation.



WARNING

**ELECTRICAL SHOCK HAZARD**

Failure to follow this warning could result in personal injury or death.

Before installing, modifying, or servicing system, main electrical disconnect switch must be in the OFF position. There may be more than 1 disconnect switch. Lock out and tag switch with a suitable warning label.



WARNING



**EXPLOSION HAZARD**

Failure to follow this warning could result in death, serious personal injury, and/or property damage.

Never use air or gases containing oxygen for leak testing or operating refrigerant compressors. Pressurized mixtures of air or gases containing oxygen can lead to an explosion.


CAUTION

**EQUIPMENT DAMAGE HAZARD**

Failure to follow this caution may result in equipment damage or improper operation.

Do not bury more than 36 in. (914 mm) of refrigerant pipe in the ground. If any section of pipe is buried, there must be a 6 in. (152 mm) vertical rise to the valve connections on the outdoor units. If more than the recommended length is buried, refrigerant may migrate to the cooler buried section during extended periods of system shutdown. This causes refrigerant slugging and could possibly damage the compressor at start-up.

#### INTRODUCTION

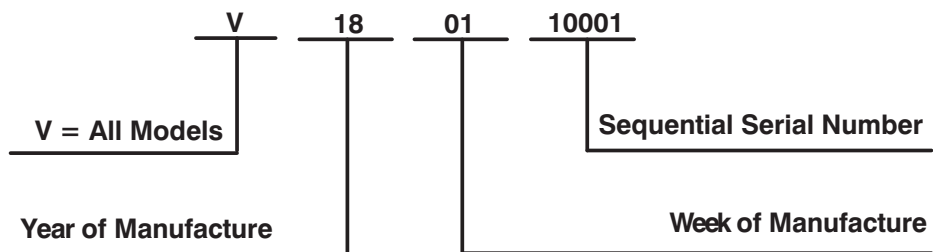
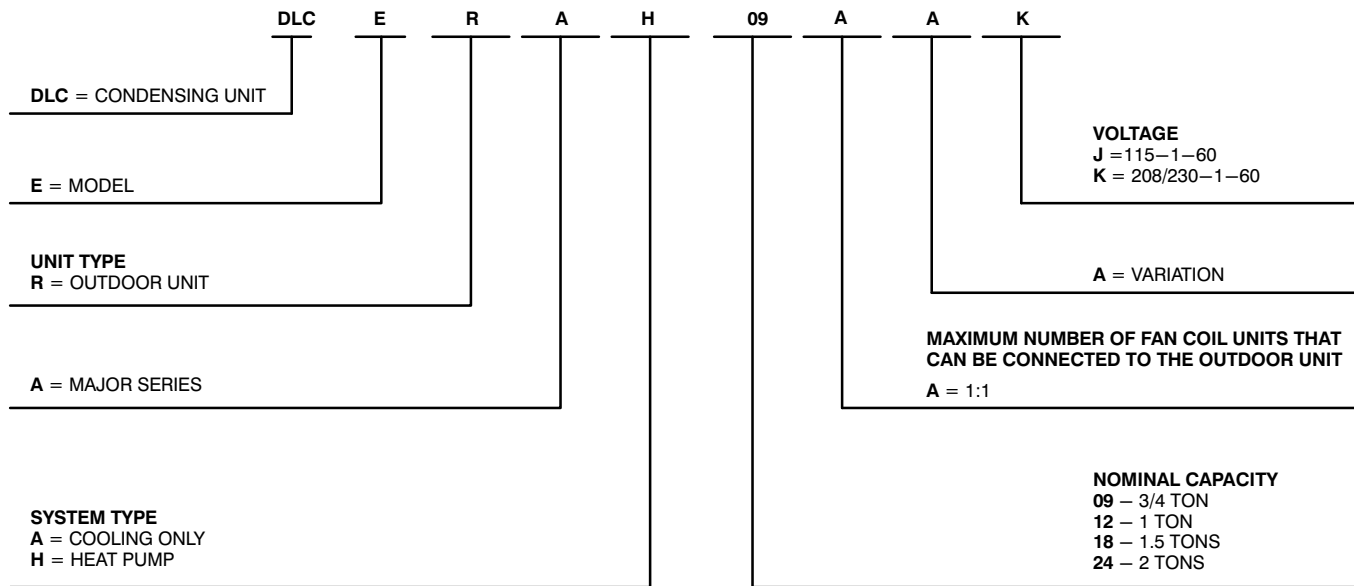
This Service Manual provides the necessary information to service, repair, and maintain the outdoor units. Section 2 of this manual has an appendix with data required to perform troubleshooting. Use the Table of Contents to locate a desired topic.

# MODEL/SERIAL NUMBER NOMENCLATURES

Table 1—Unit Sizes

	SYSTEM TONS	BTUh	VOLTAGE – PHASE	OUTDOOR MODEL
Cooling Only	1.00	12,000	115–1	DLCERAA12AAJ
	1.00	12,000	208/230–1	DLCERAA12AAK
	1.50	18,000	208/230–1	DLCERAA18AAK
	2.00	24,000	208/230–1	DLCERAA24AAK
Heating Pump	1.00	12,000	115–1	DLCERAH12AAJ
	0.75	9,000	208/230–1	DLCERAH09AAK
	1.00	12,000	208/230–1	DLCERAH12AAK
	1.50	18,000	208/230–1	DLCERAH18AAK
	2.00	24,000	208/230–1	DLCERAH24AAK

## OUTDOOR UNIT



Use of the AHRI Certified TM Mark indicates a manufacturer's participation in the program. For verification of certification for individual products, go to [www.ahridirectory.org](http://www.ahridirectory.org).



# SPECIFICATIONS

**Table 2—Specifications (Cooling Only)**

		COOLING ONLY				
System	Size		12K	12K	18K	24K
	Outdoor Model		DLCERAA12AAJ	DLCERAA12AAK	DLCERAA18AAK	DLCERAA24AAK
Electrical	Voltage, Phase, Cycle	V/Ph/Hz	115-1-60	208/230-1-60	208/230-1-60	208/230-1-60
	MCA	A.	13	7	11	16
	MOCP – Fuse Rating	A.	20	15	15	25
Operating	Cooling Outdoor DB Min – Max	° F(° C)	0~ 122 (-17~ 50)	0~ 122 (-17~ 50)	0~ 122 (-17~ 50)	0~ 122 (-17~ 50)
Piping	Total Piping Length	ft (m)	82 (25)	82 (25)	98 (30)	164 (50)
	Piping Lift*	ft (m)	33 (10)	33 (10)	66 (20)	66 (20)
	Pipe Connection Size – Liquid	In.(mm)	1/4 (6.35)	1/4 (6.35)	1/4 (6.35)	3/8 (9.52)
	Pipe Connection Size – Suction	In.(mm)	1/2 (12.7)	1/2 (12.7)	1/2 (12.7)	5/8 (16)
Refrigerant	Type		R410A	R410A	R410A	R410A
	Charge	lbs (kg)	1.30 (0.59)	1.30 (0.59)	2.09 (0.95)	2.64 (1.20)
	Metering Device		EEV	EEV	EEV	EEV
Outdoor Coil	Face Area	Sq. Ft.	4.15	4.15	4.78	4.78
	No. Rows		1	1	2	2
	Fins per inch		22	22	22	22
	Circuits		2	2	4	6
Compressor	Type		Rotary Inverter	Rotary Inverter	Rotary Inverter	Rotary Inverter
	Model		ASN98D22UFZ	ASN98D22UFZ	ASM135D23UFZ	ATF235D22UMT
	Oil Type		VG74	VG74	VG74	VG74
	Oil Charge	Fl. Oz.	13.0	13.0	13.0	23.6
	Rated Current	RLA	9.5	4.5	7.0	11.0
Outdoor	Unit Width	In.(mm)	30.31(770)	30.31(770)	31.50(800)	33.27(845)
	Unit Height	In.(mm)	21.85(555)	21.85(555)	21.81(554)	27.64(702)
	Unit Depth	In.(mm)	11.81(300)	11.81(300)	13.11(333)	14.29(363)
	Net Weight	lbs (kg)	57.8(26.2)	53.8(24.4)	70.1(31.8)	88.6(40.2)
	Airflow	CFM	1,170	1,170	1,170	1,880
	Sound Pressure	dB(A)	52.0	54.0	57.0	59.5

\* Condensing unit above or below the indoor unit

# SPECIFICATIONS (CONT)

Table 3—Specifications (Heat Pump)

		HEAT PUMP					
System	Size		12	9	12	18	24
	Outdoor Model		DLCERAH12AAJ	DLCERAH09AAK	DLCERAH12AAK	DLCERAH18AAK	DLCERAH24AAK
Electrical	Voltage, Phase, Cycle	V/Ph/Hz	115-1-60	208/230-1-60	208/230-1-60	208/230-1-60	208/230-1-60
	MCA	A.	13	8	10	15	18
	MOCP – Fuse Rating	A.	20	15	15	20	25
Operating Range	Cooling Outdoor DB Min – Max	° F(° C)	0~ 122 (-17~ 50)	0~ 122 (-17~ 50)	0~ 122 (-17~ 50)	0~ 122 (-17~ 50)	0~ 122 (-17~ 50)
	Heating Outdoor DB Min – Max	° F(° C)	0~ 86 (-17~ 30)	0~ 86 (-17~ 30)	0~ 86 (-17~ 30)	0~ 86 (-17~ 30)	0~ 86 (-17~ 30)
Piping	Total Piping Length	ft (m)	82 (25)	82 (25)	82 (25)	98 (30)	164 (50)
	Piping Lift*	ft (m)	33 (10)	33 (10)	33 (10)	66 (20)	66 (20)
	Pipe Connection Size – Liquid	In.(mm)	1/4 (6.35)	1/4 (6.35)	1/4 (6.35)	1/4 (6.35)	3/8 (9.52)
	Pipe Connection Size – Suction	In.(mm)	1/2 (12.7)	3/8 (9.52)	1/2 (12.7)	1/2 (12.7)	5/8 (16)
Refrigerant	Type		R410A	R410A	R410A	R410A	R410A
	Charge	lbs (kg)	2.11 (0.96)	1.76 (0.80)	2.11 (0.96)	2.82 (1.28)	3.97 (1.80)
	Metering Device		EEV	EEV	EEV	EEV	EEV
Outdoor Coil	Face Area	Sq. Ft.	4.1	4.1	4.1	4.7	5.3
	No. Rows		1.5	1	1.5	2	2
	Fins per inch		18	18	18	18	18
	Circuits		4	2	4	4	4
Compressor	Type		Rotary Inverter	Rotary Inverter	Rotary Inverter	Rotary Inverter	Rotary Inverter
	Model		ASN98D22UFZ	ASN98D22UFZ	ASN98D22UFZ	ASM135D23UFZ	ATF235D22UMT
	Oil Type		VG74	VG74	VG74	VG74	VG74
	Oil Charge	Fl. Oz.	13.0	13.0	13.0	15.8	23.6
	Rated Current	RLA	9.5	5.5	6.8	10.5	12.0
Outdoor	Unit Width	In.(mm)	30.31(770)	30.31(770)	30.31(770)	31.50(800)	33.27(845)
	Unit Height	In.(mm)	21.85(555)	21.85(555)	21.85(555)	21.81(554)	27.64(702)
	Unit Depth	In.(mm)	11.81(300)	11.81(300)	11.81(300)	13.11(333)	14.29(363)
	Net Weight	lbs (kg)	69.0(31.3)	63(28.6)	65.5(29.7)	79.6(36.1)	114.2(51.8)
	Airflow	CFM	1,170	1,170	1,170	1,170	1,765
	Sound Pressure	dB(A)	54.5	57.2	57.4	57.0	60.2

\* Condensing unit above or below the indoor unit



# DIMENSIONS

Table 4—Dimensions

	System Size		Height (H) in. (mm)	Width (W) in. (mm)	Depth (D) in. (mm)	Weight—Net lbs. (kg)
	Cooling Only	12K	(115V)	21.85(555)	30.31(770)	11.81(300)
12K		(208/230V)	21.85(555)	30.31(770)	11.81(300)	53.8(24.4)
18K		(208/230V)	21.81(554)	31.50(800)	13.11(333)	70.1(31.8)
24K		(208/230V)	27.64(702)	33.27(845)	14.29(363)	88.6(40.2)
	System Size		Height (H) in. (mm)	Width (W) in. (mm)	Depth (D) in. (mm)	Weight—Net lbs. (kg)
	Heat Pump	12K	(115V)	21.85(555)	30.31(770)	11.81(300)
9K		(208/230V)	21.85(555)	30.31(770)	11.81(300)	63.0(28.6)
12K		(208/230V)	21.85(555)	30.31(770)	11.81(300)	65.5(29.7)
18K		(208/230V)	21.81(554)	31.50(800)	13.11(333)	79.6(36.1)
24K		(208/230V)	27.64(702)	33.27(845)	14.29(363)	114.2(51.8)

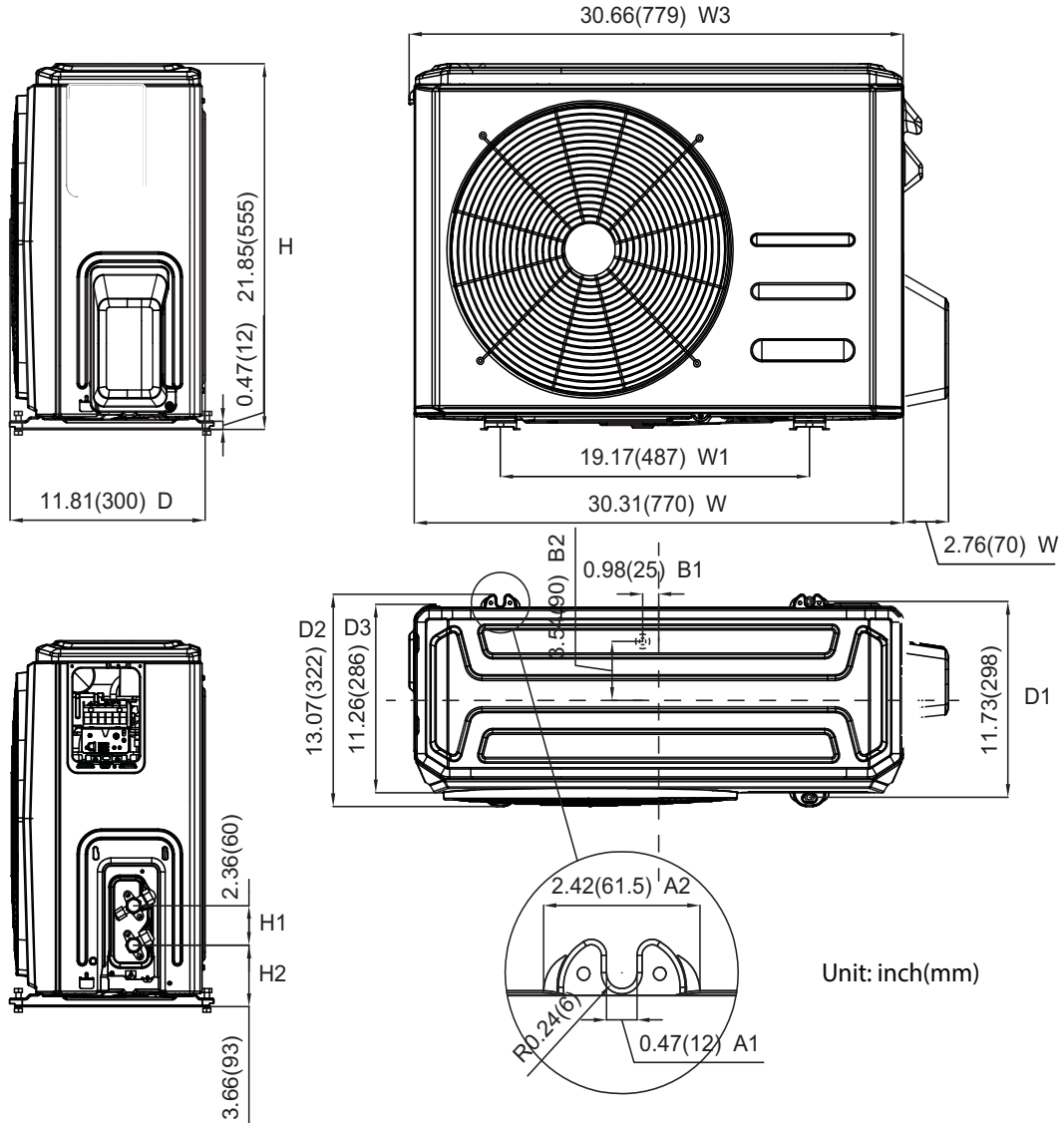
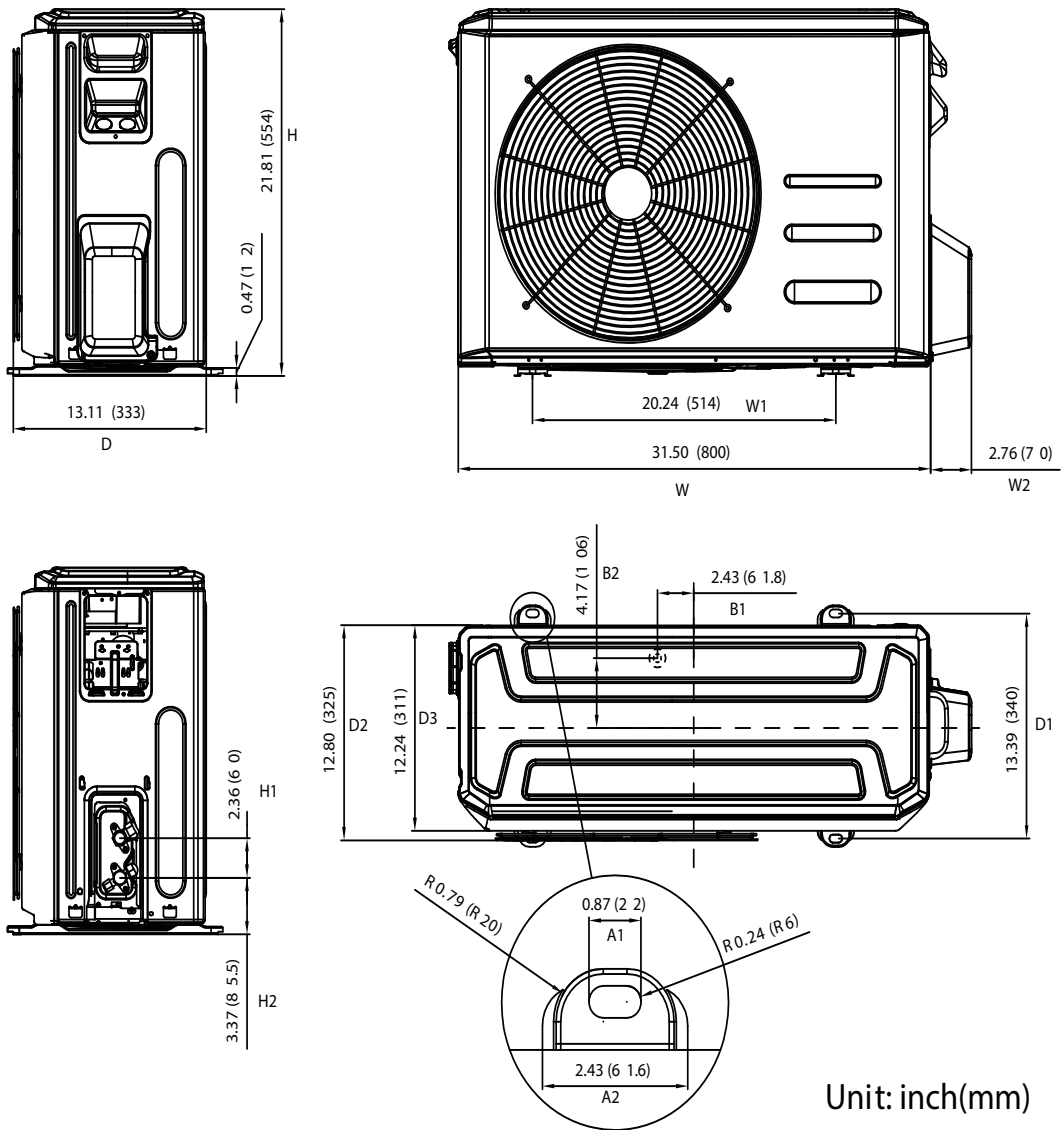


Fig. 1 – Sizes 9K and 12K

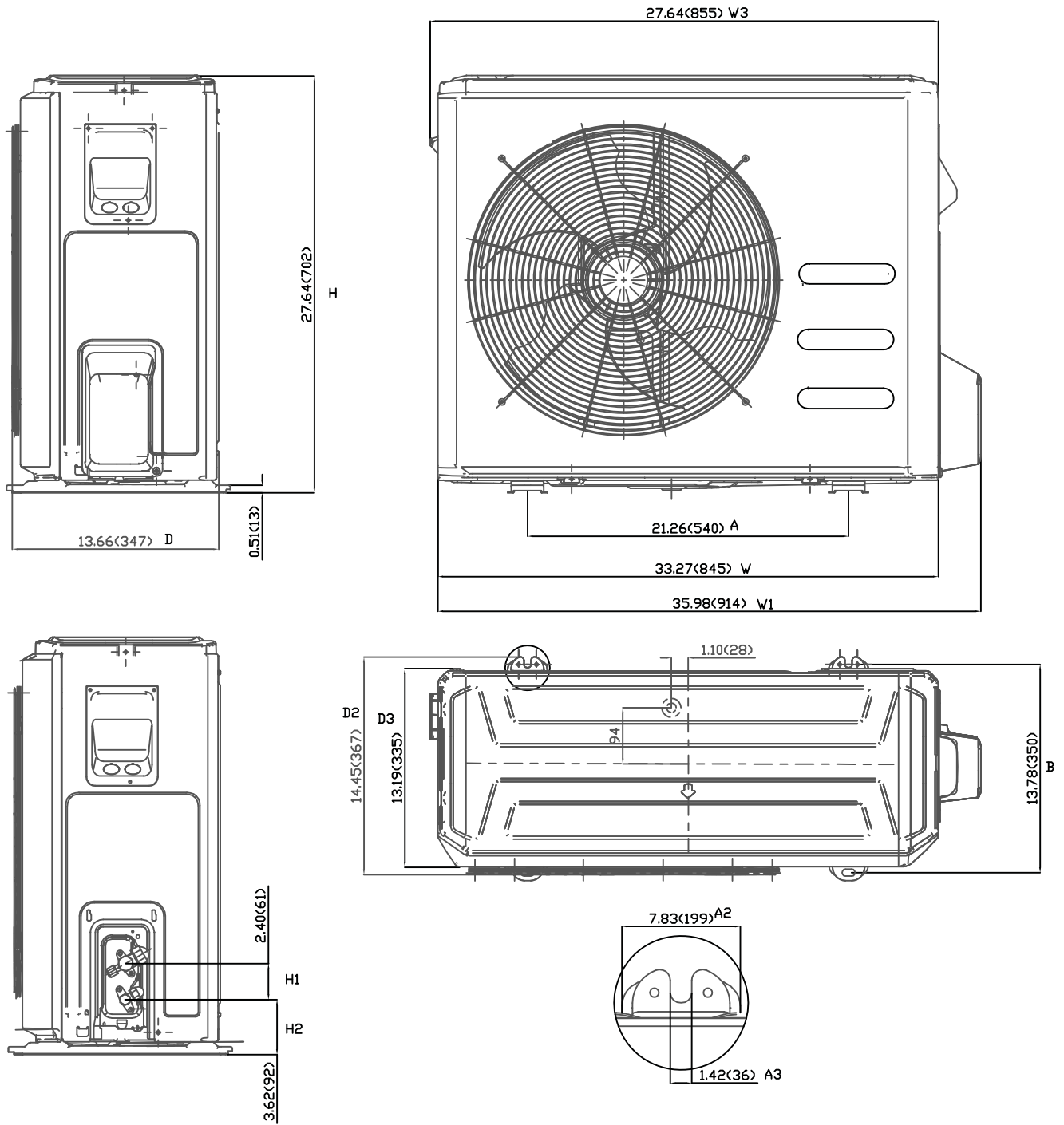
# DIMENSIONS – OUTDOOR (CONT)



Unit: inch(mm)

Fig. 2 – Size 18K

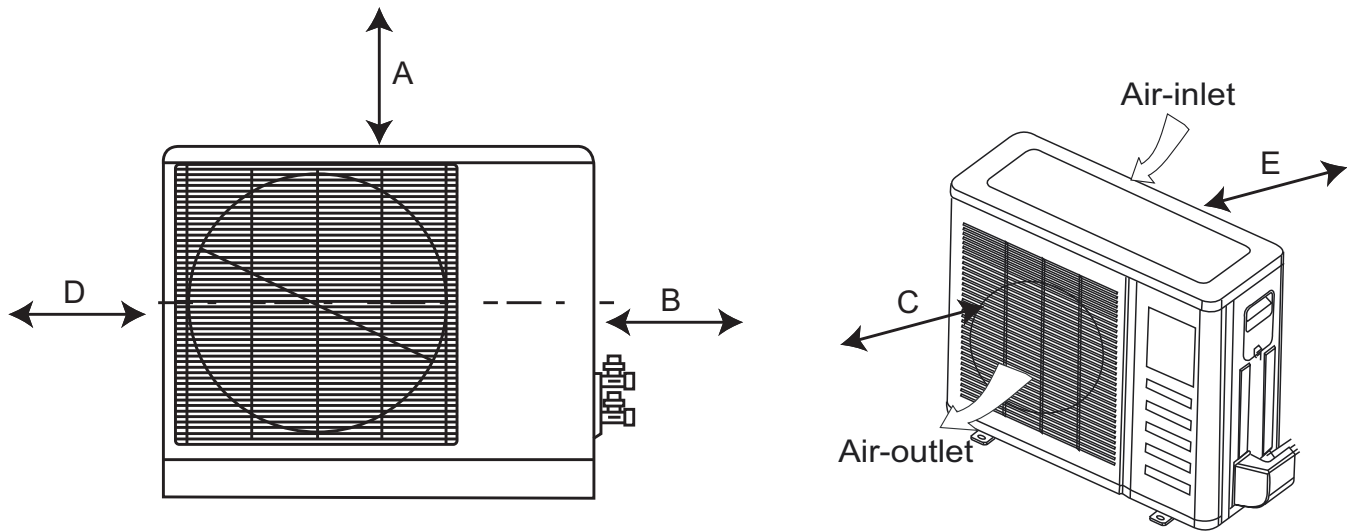
# DIMENSIONS – OUTDOOR (CONT)



Unit: inch (mm)

Fig. 3 – Size 24K

# CLEARANCES

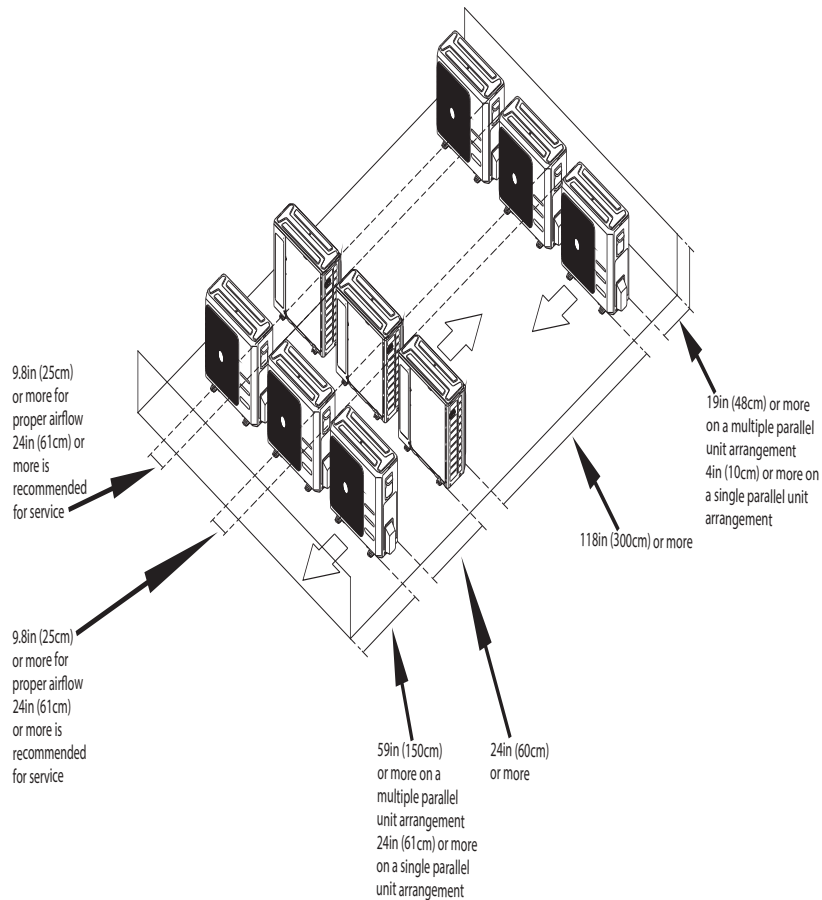


**Fig. 4 – Outdoor Unit Clearance**

**Table 5—Clearances**

UNIT	MINIMUM VALUE in. (mm)
A	24 (610)
B	24 (610)
C	24 (610)
D	4 (101)
E	4 (101)

**NOTE:** The outdoor unit must be mounted at least 2in. (50mm) above the maximum anticipated snow depth.



**Fig. 5 – Clearances for Multiple Units**

# ELECTRICAL DATA

Table 6—Electrical Data

Cooling Only	Outdoor Unit Size	12K	12K	18K	24K
	Volts—PH—Hz	(115V)	(208/230V)	(208/230V)	(208/230V)
	Max – Min* Oper. Voltage	127–104	253–187	253–187	253–187
Power Supply	MCA	7	7	11	16
	MOCP	15	15	15	25
Compressor	RLA	9.5	4.5	7	11
Outdoor Fan Motor	FLA	0.6	0.4	0.5	0.6
	Rated HP	0.054	0.054	0.065	0.068
	Output	40	40	48	45

Heat Pump	Outdoor Unit Size	12K	9K	12K	18K	24K
	Volts—PH—Hz	(115V)	(208/230V)	(208/230V)	(208/230V)	(208/230V)
	Max – Min* Oper. Voltage	127–104	253–187	253–187	253–187	253–187
Power Supply	MCA	13	8	10	15	18
	MOCP	20	15	15	20	25
Compressor	RLA	10.5	5.5	6.8	11.5	12
Outdoor Fan Motor	FLA	0.6	0.4	0.4	0.5	0.6
	Rated HP	0.054	0.054	0.054	0.054	0.068
	Output	40	40	40	40	50

\*Permissible limits of the voltage range at which the unit will operate satisfactorily.

## LEGEND

- FLA – Full Load Amps
- MCA – Minimum Circuit Amps
- MOCP – Maximum Over-Current Protection
- RLA – Rated Load Amps

## WIRING

All wires must be sized per NEC (National Electrical Code) or CEC (Canadian Electrical Code) and local codes. Use Electrical Data table MCA (minimum circuit amps) and MOCP (maximum over current protection) to correctly size the wires and the disconnect fuse or breakers respectively.

### Recommended Connection Method for Power and Communication Wiring:

The main power is supplied to the outdoor unit. The field supplied 14/3 stranded wire with ground with a 600 volt insulation rating, power/communication wiring from the outdoor unit to indoor unit consists of four (4) wires and provides the power for the indoor unit. Two wires are line voltage AC power, one is communication wiring (S) and the other is a ground wire. Wiring between indoor and outdoor unit is polarity sensitive. The use of BX wire is NOT recommended.

If installed in a high Electromagnetic field (EMF) area and communication issues exists, a 14/2 stranded shielded wire can be used to replace L2/N and (S) between outdoor unit and indoor unit landing the shield onto ground in the outdoor unit only.

**CAUTION**

**EQUIPMENT DAMAGE HAZARD**  
 Failure to follow this caution may result in equipment damage or improper operation.  
 Wires should be sized based on NEC and local codes.

**CAUTION**

**EQUIPMENT DAMAGE HAZARD**  
 Failure to follow this caution may result in equipment damage or improper operation.

- Be sure to comply with local codes while running wire from the indoor unit to the outdoor unit.
- Every wire must be connected firmly. Loose wiring may cause the terminal to overheat or result in unit malfunction. A fire hazard may also exist. Ensure all wiring is tightly connected.
- No wire should touch the refrigerant tubing, compressor or any moving parts.
- Disconnecting means must be provided and shall be located within sight and readily accessible from the air conditioner.
- Connecting cable with conduit shall be routed through the hole in the conduit panel.

# CONNECTION DIAGRAM

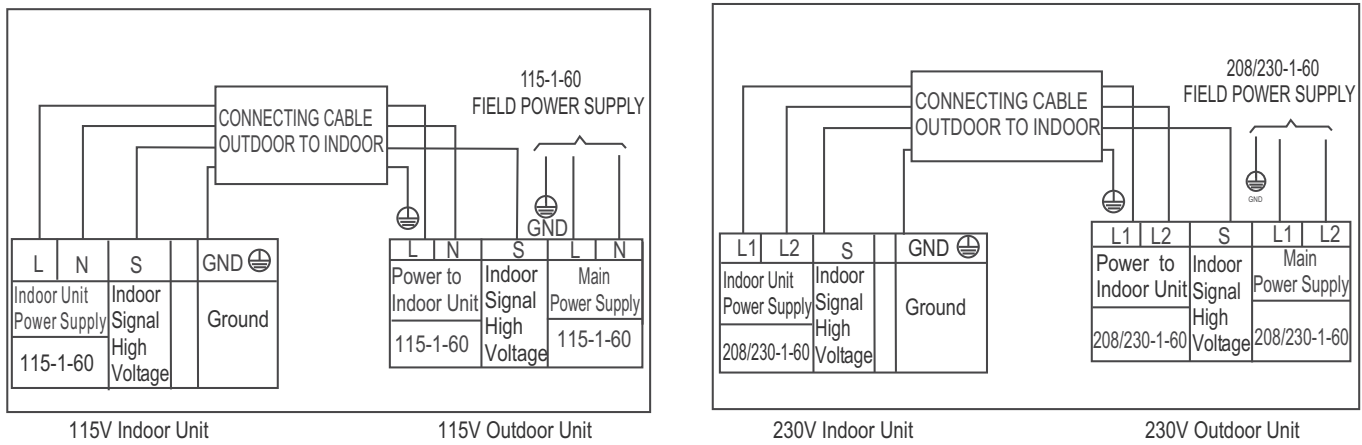


Fig. 6 – Connection Diagrams

- Notes:**
1. Do not use thermostat wire for any connection between indoor and outdoor units.
  2. All connections between indoor and outdoor units must be as shown. **The connections are sensitive to polarity and will result in a fault code.**

# WIRING DIAGRAMS

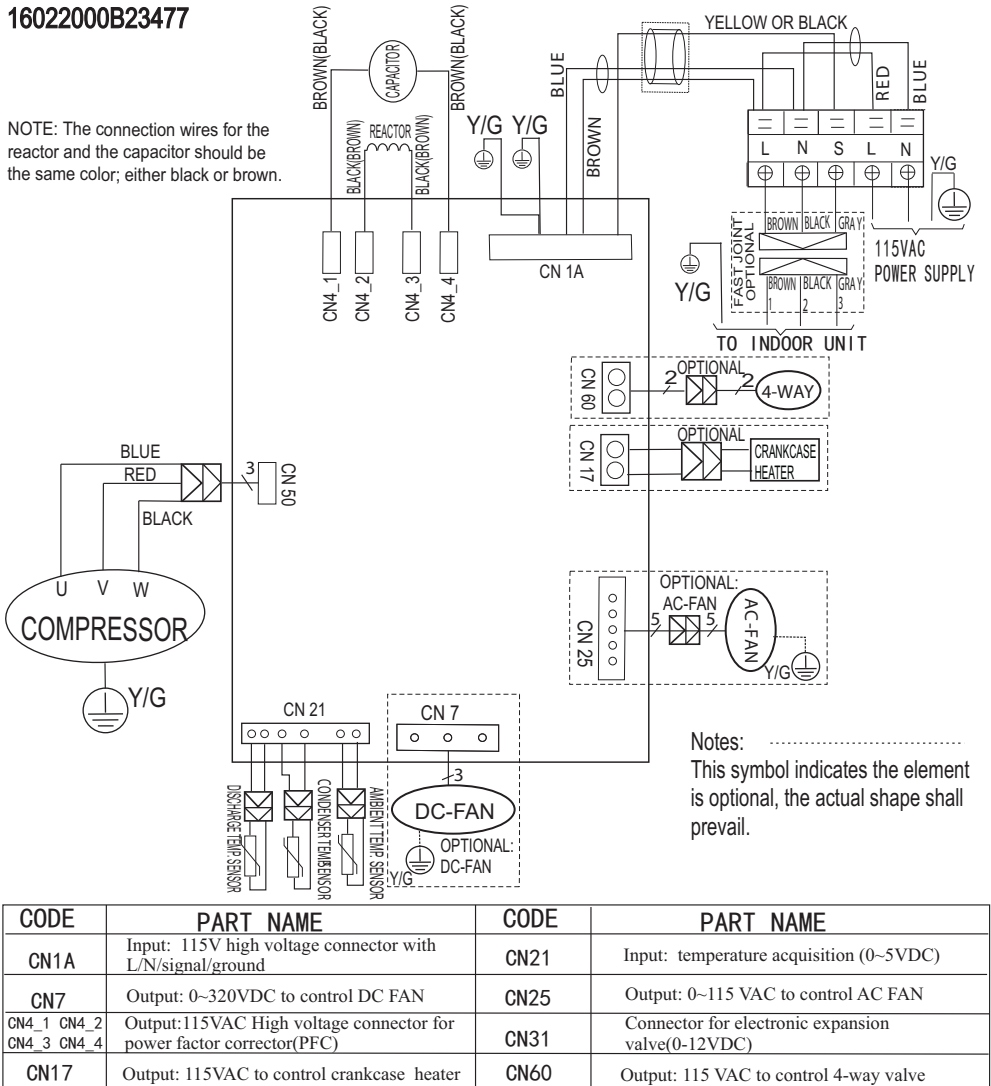
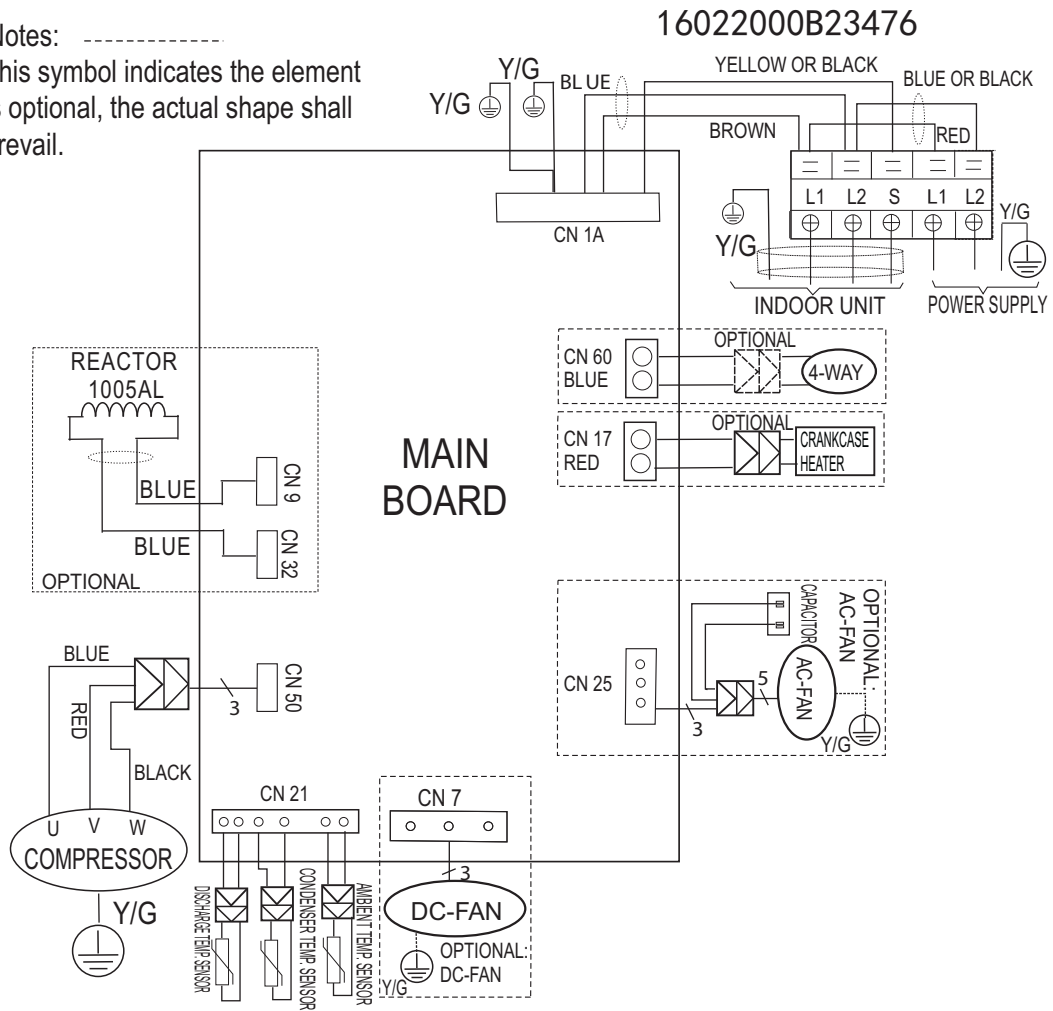


Fig. 7 – Wiring Diagram Size 12K (115V)

WIRING DIAGRAMS (CONT)

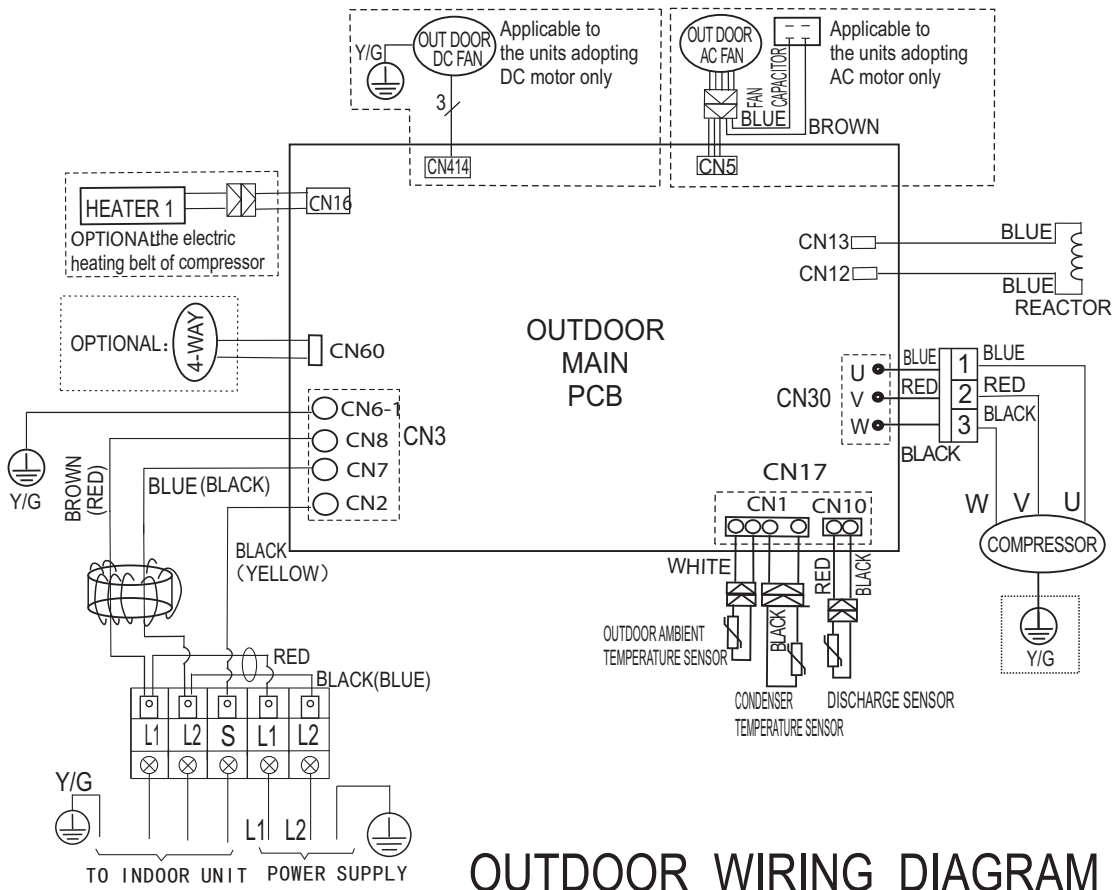
Notes: -----  
 This symbol indicates the element is optional, the actual shape shall prevail.



CODE	PART NAME	CODE	PART NAME
CN1A	Input: 220V high voltage connector with L/N/signal/ground	CN21	Input: temperature sensor connector (0~5V DC)
CN7	Output: 0~320V DC to connect DC FAN	CN25	Output: 0~220V AC to connect AC FAN
CN9~CN32	To connect PFC reactor	CN50	Output: 0~320V AC to connect compressor
CN17	Output: 220V AC to connect crankcase heater	CN60	Output: 0~220V AC to connect 4-way valve

Fig. 8 – Wiring Diagram – Sizes 09K, 12K (208–230V)

WIRING DIAGRAMS (CONTINUED)



OUTDOOR WIRING DIAGRAM

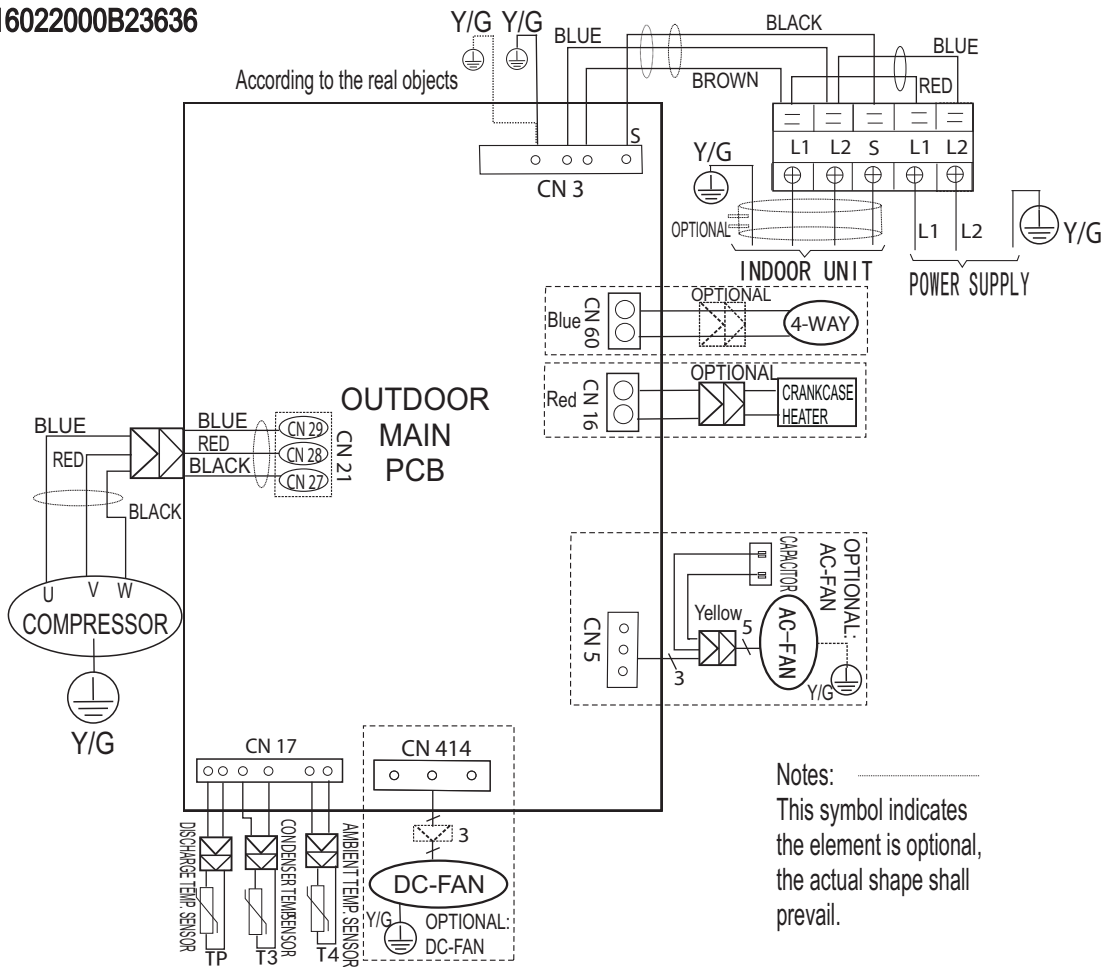
CODE	PART NAME	CODE	PART NAME
CN3	Input: 230V high voltage connector with L1/L2/signal/ground	CN5	Output: 0~220VAC to control AC FAN
CN30	Output: PWM for UVW to control Compressor(0~320VAC)	CN16	Output: 220V AC to control crankcase heater
CN17	Input: Temperature acquisition(0-5VDC)	CN60	Output: 0~220V AC to control 4-way valve
CN414	Output: 0~320VDC to control DC FAN	CN12/CN13	Output: Connection of the high voltage (REACTOR)

Fig. 9 – Wiring Diagram Sizes 18K – 24K (Heat Pump Units)



WIRING DIAGRAMS (CONTINUED)

16022000B23636



CODE	PART NAME	CODE	PART NAME
CN3	Input: 220V high voltage connector with L1/L2/signal/ground	CN5	Output: 0~220VAC to control AC FAN
CN21	Output: PWM for UVW to control Compressor(0~320VAC)	CN16	Output: 220V AC to control crankcase heater
CN17	Input: Temperature acquisition(0-5VDC)	CN60	Output: 0~220V AC to control 4-way valve
CN414	Output: 0~320VDC to control DC FAN		

Fig. 10 – Wiring Diagram Sizes 18K – 24K (Cooling Only Units)

# REFRIGERATION CYCLE DIAGRAMS

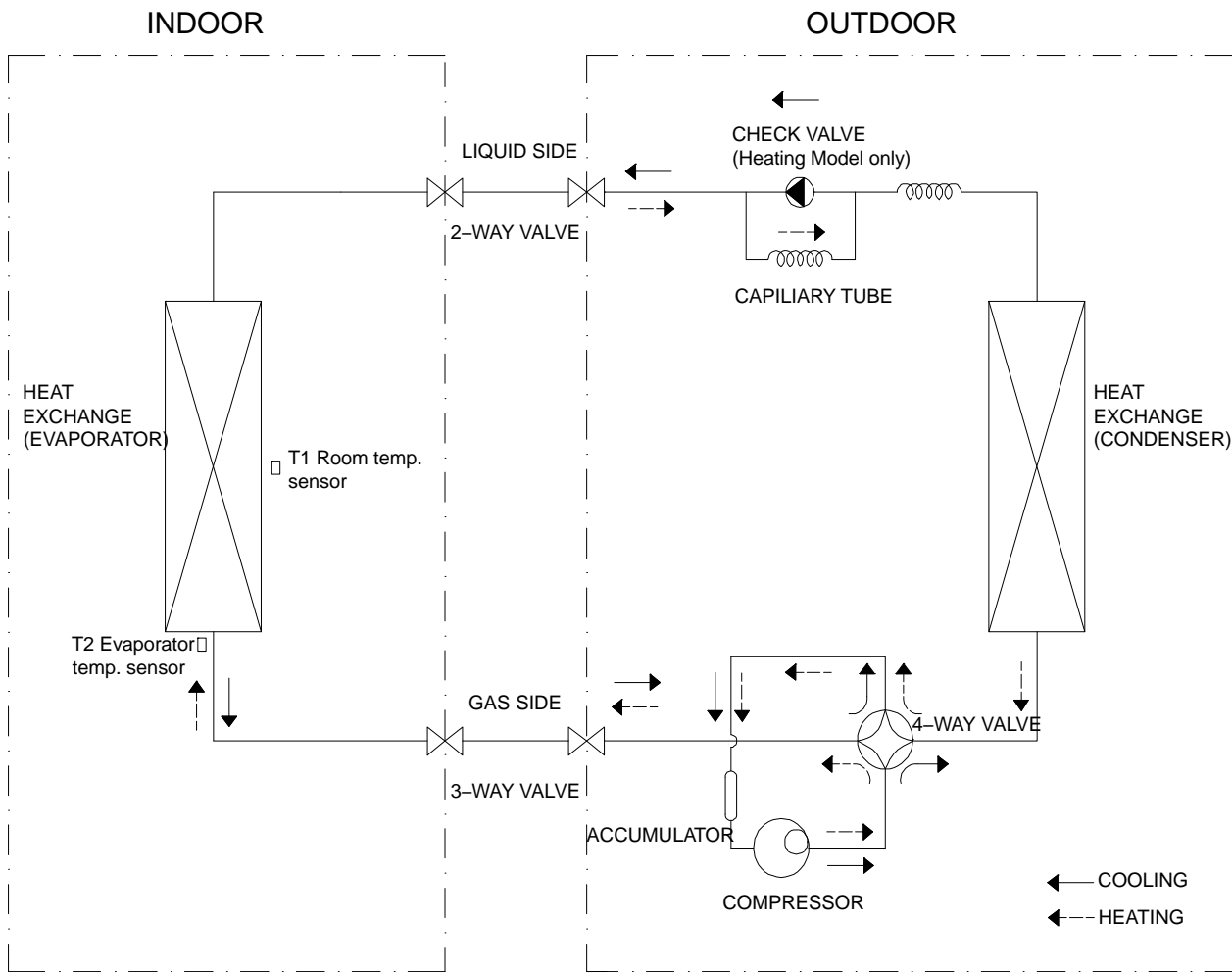


Fig. 11 – Heat Pumps

# REFRIGERANT LINES

## General Refrigerant Line Sizing

1. The outdoor units are shipped with a full charge of R410A refrigerant. All charges, line sizing, and capacities are based on runs of 25ft. (7.6 m). For runs over 25 ft. (7.6 m), consult the long-line applications section for the proper charge adjustments.
2. The minimum refrigerant line length between the indoor and outdoor units is 10 ft. (3 m).
3. Refrigerant lines should not be buried in the ground. If it is necessary to bury the lines, not more than 36 in (914 mm) should be buried. Provide a minimum 6in (152 mm) vertical rise to the service valves to prevent refrigerant migration.
4. Both lines must be insulated. Use a minimum of 1/2in. (12.7 mm) thick insulation. Closed-cell insulation is recommended in all long-line applications.
5. Special consideration should be given to isolating interconnecting tubing from the building structure. Isolate the tubing so vibration or noise is not transmitted into the structure.

**IMPORTANT: Both refrigerant lines must be insulated separately.**

Table 7 lists the maximum lengths allowed.

**Table 7—Piping and Refrigerant Information**

System Size			12V (115V)	9K (208–230V)	12K (208–230V)	18 (208–230V)	24K (208–230V)
Piping	Min. Piping Length	ft. (m)	9.8(3)	9.8(3)	9.8(3)	9.8(3)	9.8(3)
	Standard Piping Length	ft. (m)	24.6(7.5)	24.6(7.5)	24.6(7.5)	24.6(7.5)	24.6(7.5)
	Max. outdoor–indoor height difference (OU higher than IU)	ft. (m)	32(10)	32(10)	32(10)	65(20)	65(20)
	Max. outdoor–indoor height difference (IU higher than OU)	ft. (m)	33(10)	33(10)	33(10)	66(20)	66(20)
	Max. Piping Length with no additional refrigerant charge per System (Standard Piping length)	ft. (m)	24.6(7.5)	24.6(7.5)	24.6(7.5)	24.6(7.5)	24.6(7.5)
	Total Max. Piping Length per system	ft. (m)	82(25)	82(25)	82(25)	98(30)	98(50)
	Additional refrigerant charge (between Standard – Max piping length)	Oz/ft (g/m)	0.161(15)	0.161(15)	0.161(15)	0.161(15)	0.322(30)
	Suction Pipe (size – connection type)	In (mm)	ø1/2(12.7)	ø3/8(9.52)	ø1/2(12.7)	ø1/2(12.7)	ø5/8(15.9)
	Liquid Pipe (size – connection type)	In (mm)	ø1/4(6.35)	ø1/4(6.35)	ø1/4(6.35)	ø1/4(6.35)	ø3/8(9.52)
Refrigerant	Refrigerant Type	Type	R410A	R410A	R410A	R410A	R410A
	Cooling Only Models Charge Amount	Lbs (kg)	1.30(0.59)	1.06(0.48)	1.30(0.59)	2.1(0.95)	2.65(1.2)
	Heat Pump Models Charge Amount	Lbs (kg)	2.12(0.96)	1.76(0.8)	2.12(0.96)	2.82(1.28)	3.97(1.8)

### Long Line Applications:

1. No change in line sizing is required.
2. Add refrigerant per Table 7.

# SYSTEM EVACUATION AND CHARGING

**⚠ CAUTION**

**UNIT DAMAGE HAZARD**

Failure to follow this caution may result in equipment damage or improper operation.

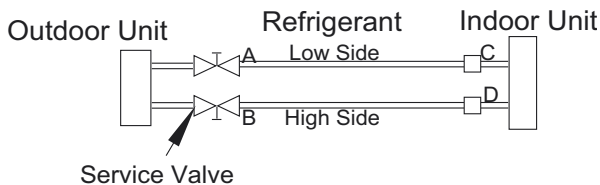
Never use the system compressor as a vacuum pump.

Refrigerant tubes and indoor coil should be evacuated using the recommended deep vacuum method of 500 microns. Always break a vacuum with dry nitrogen.

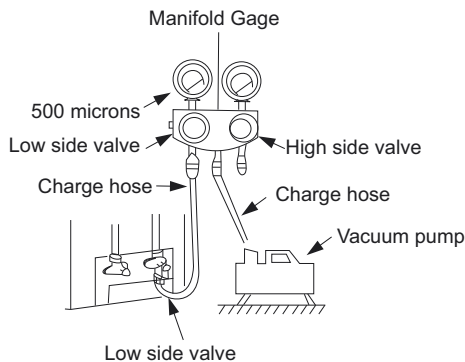
## System Vacuum and Charge

### Using Vacuum Pump

1. Completely tighten all flare nuts and connect manifold gage charge hose to a charge port of the low side service valve (see Fig. 12).
2. Connect the charge hose to the vacuum pump.
3. Fully open the low side of manifold gage (see Fig. 13).
4. Start the vacuum pump
5. Evacuate using the triple evacuation method.
6. After evacuation is complete, fully close the low side of manifold gage and stop the vacuum pump operation.
7. The factory charge contained in the outdoor unit is good for up to 25 ft. (8 m) of line length. For refrigerant lines longer than 25 ft. (8 m), add refrigerant as specified in the *ADDITIONAL REFRIGERANT CHARGE* table in this document.
8. Disconnect the charge hose from the charge connection of the low side service valve.
9. Fully open service valves B and A.
10. Securely tighten the service valves caps.



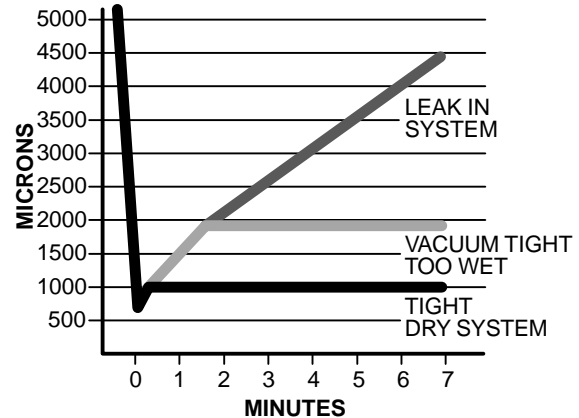
**Fig. 12 – Service Valve**



**Fig. 13 – Manifold**

### Deep Vacuum Method

The deep vacuum method requires a vacuum pump capable of pulling a vacuum of 500 microns and a vacuum gage capable of accurately measuring this vacuum depth. The deep vacuum method is the most positive way of assuring a system is free of air and liquid water (see Fig. 14).

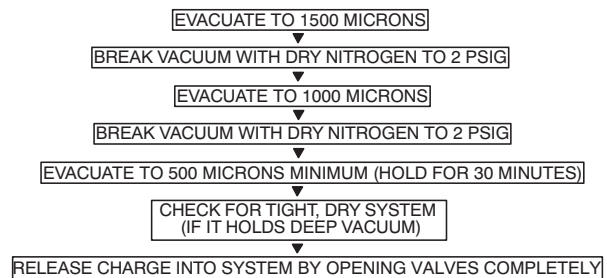


**Fig. 14 – Deep Vacuum Graph**

### Triple Evacuation Method

The triple evacuation method should be used. Refer to Fig. 15 and proceed as follows:

1. Pump the system down to 1500 microns and allow the pump to continue operating for an additional 15 minutes.
2. Close the service valves and shut off the vacuum pump.
3. Connect a dry nitrogen cylinder and regulator to the system and break vacuum until the system reaches 2 psig.
4. Close the service valve and allow the system to stand for 1hr. During this time, the dry nitrogen can diffuse throughout the system absorbing moisture.
5. Pump the system down to 1000 microns.
6. Break the vacuum with dry nitrogen (2 psig).
7. Pump the system down to 500 microns.
8. Perform the hold test for 30 minutes.



**Fig. 15 – Triple Evacuation Method**

### Final Tubing Check

**IMPORTANT:** Check to be certain factory tubing on both indoor and outdoor unit has not shifted during shipment. Ensure tubes are not rubbing against each other or any sheet metal. Pay close attention to feeder tubes, making sure wire ties on feeder tubes are secure and tight.

# ELECTRONIC FUNCTIONS

## Abbreviation

- T1: Indoor room temperature
- T2: Coil temperature of evaporator
- T3: Coil temperature of condenser
- T4: Outdoor ambient temperature
- T5: Compressor discharge temperature

## Display function

### Icon explanation on indoor display board



**Fig. 16 – Digital display**

- Displays the temperature settings when the air conditioner is operational.
- Displays the room temperature in FAN mode.
- Displays the self–diagnostic codes.
- Displays **ON** for three seconds when Timer ON, Fresh, Swing, Turbo or Silence feature is activated.
- Displays **OF** for three seconds when Fresh, Swing, Turbo, or Silence feature is cancelled.
- Displays **DF** under defrosting operation.
- Displays **CF** when anti–cold air feature is activated under heating mode.
- Displays **SC** during self clean operation (if applicable).
- Displays **FP** under 8°C heating operation (if applicable).
- When ECO function (optional) is activated, the **88**

**E → [ → 0 → set temperature → E ...**

in one second intervals.



**Fig. 17 – WIFI control display (optional)**

Displays when the WIFI control feature is activated (Not available on some units).

**NOTE:** A guide on using the infrared remote is not included in this literature package.

## **Main Protection**

### Three minute delay for compressor restart

Less than a 1 minute delay for the initial start – up and a 3 minute delay for subsequent starts.

### Compressor top temperature protection

The unit stops working when the compressor top temperature protector cuts off, and restarts after the compressor top temperature protector restarts.

### Compressor discharge temperature protection

Compressor discharge temp. T5>239°F(115°C) for 5s, compressor stops.

### Fan Speed is Out of Control

When the indoor fan speed remains too low (300RPM) the unit stops and the LED displays the failure.

### Inverter module protection

The inverter module has a protection function for current, voltage and temperature. If any of these protections engage, the corresponding code displays on the indoor unit and the unit stops working.

### Compressor preheating functions

Preheating permitting condition: When the T4 (outdoor ambient temperature)<37.4°F (3°C), the preheating function engages.

### Zero Crossing Detection Error Protection

If the AC detects that the time interval is not correct for a continuous period of 240s, the unit stops and the LED displays the failure. The correct zero crossing signal time interval should be between 6–13ms.

### Sensor Protection at Open Circuit and Breaking Disconnection

When there is only one malfunctioning temperature sensor, the air conditioner keeps working yet displays the error code, in case of any emergency use. When there is more than one malfunctioning temperature sensor, the air conditioner stops working.

### Refrigerant leakage detection

This function is only active in the **COOLING** mode. The function helps prevent the compressor from being damaged by a refrigerant leakage or a compressor overload.

Open condition:

When the compressor is active, the evaporator T2 coil temperature value has no or very little change.

## **Operation Modes and Functions**

### FAN Mode

1. Outdoor fan and compressor stop
2. Temperature setting function is disabled, and no setting temperature is displayed.
3. Indoor fan can be set to high/med/low/auto
4. The louver operates the same in the **COOLING** mode.
5. Auto fan

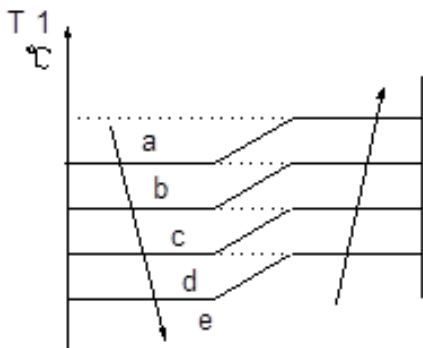


Fig. 18 – Auto Fan

**COOLING Mode**

**Compressor Running Rules:**

- When  $T1 - T_s < 28.4^\circ\text{F} (-2^\circ\text{C})$ , the compressor stops.
- When  $T1 - T_s > 31.1^\circ\text{F} (-0.5^\circ\text{C})$ , the compressor activates.
- When the AC runs in the mute mode, the compressor runs with low frequency.
- When the current is more than setting value, the current protection function activates, and the compressor stops.

**Outdoor Fan Running Rules:**

The outdoor unit runs at a different fan speed according to  $T4$ . For different outdoor units, the fan speeds differ.

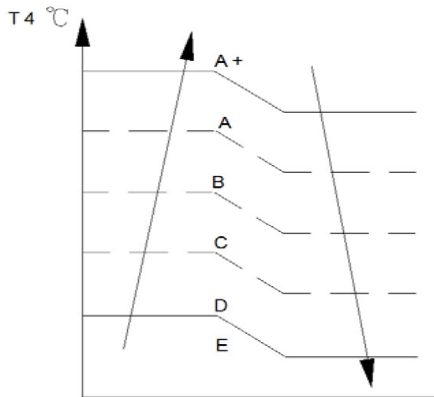


Fig. 19 – Outdoor Fan Running Rules

The auto fan adheres to the following rules.

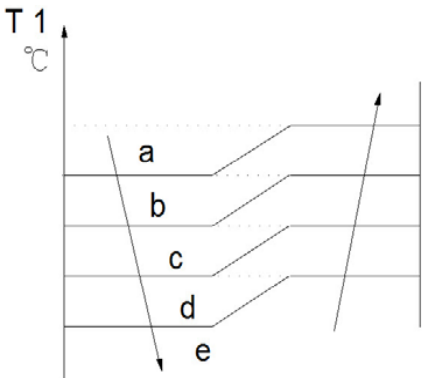


Fig. 20 – Auto Fan

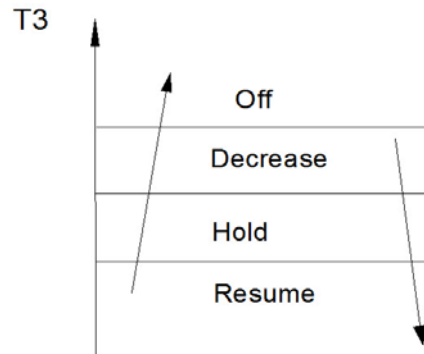


Fig. 21 – Compressor Temperature Protection

When the condenser temperature is higher than the setting value, the compressor stops.

**Compressor Running Rules**

When  $T1 - T_s > -\Delta T$ , the compressor stops, when  $T1 - T_s < \Delta T - 1.5$ , the compressor will be on.  $\Delta T$  is the programmed parameter of temperature compensation. When the AC run in mute mode, the compressor runs with low frequency.

When the current is more than setting value, the current protection function is activated and the compressor stops.

**Outdoor Fan Running Rules**

The outdoor unit runs at different fan speed according to  $T4$ . For different outdoor units, the fan speeds are different.

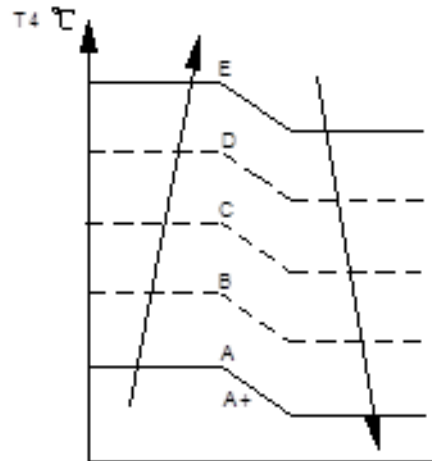


Fig. 22 – Outdoor Fan Running Rules

**Auto Fan Action in HEATING Mode**

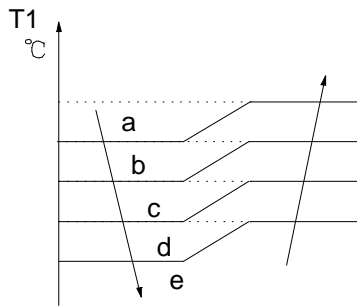


Fig. 23 – Auto Fan Action in HEATING Mode

### DEFROST Mode

The air conditioner enters the **DEFROST** mode according to the T3 temperature value and the T3 temperature change value range plus the compressor running time.

During the **DEFROST** mode, the compressor continues to run, the indoor and outdoor motors stop, and the indoor unit defrost lamp illuminates and **df** appears.

If any one of the following items is satisfied, the defrosting finishes and the machine reverts to the normal heating mode.

- T3 rises to be higher than TCDE1°C.
- T3 keeps to be higher than TCDE2°C for 80 seconds.
- The machine has run for 15 minutes in defrosting mode.

### Evaporator Coil Temperature Protection

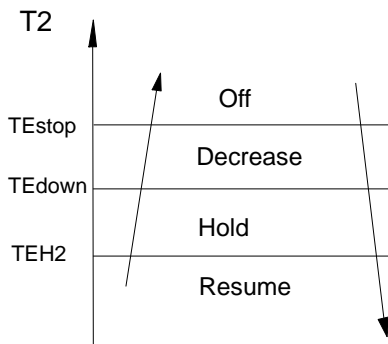


Fig. 24 – Evaporator Coil Temperature Protection

**NOTE:** The following applies to Fig. 24:

- Off: Compressor stops
- Decrease: Decrease the running frequency to the lower level
- Hold: Keep the current frequency
- Resume: No limitation for frequency

When the evaporator temperature is higher than the setting protection value, the compressor stops.

### Auto-Mode

This mode can be chosen with the remote controller and the setting temperature can be changed between 62.6°F(17°C)~86°F(30°C).

In the **AUTO** mode, the machine chooses the **COOLING**, **HEATING** or **FAN-ONLY** mode according to  $\Delta T$  ( $\Delta T = T1 - Ts$ ).

Table 8—Auto Mode

$\Delta T = T1 - Ts$	Running mode
$\Delta T > 2^\circ\text{C}$	Cooling
$-2 \leq \Delta T \leq 2^\circ\text{C}$	Fan-only
$\Delta T < -2^\circ\text{C}$	Heating

The indoor fan runs under auto fan in the relevant mode. The louver operates same as in relevant mode. If the machine switches mode between **HEATING** and **COOLING**, the compressor stops for 15 minutes and then chooses the mode according to T1-Ts. If the setting temperature is modified, the machine chooses the running function again.

### DRY mode

**Indoor fan speed is fixed at breeze and can not be changed.**

The louver angle is the same as in the cooling mode.

### Low indoor room temperature protection

In the **DRYING** mode, if the room temperature is lower than 50°F (10°C), the compressor stops and does not resume until the room temperature exceeds 53.6°F (12°C).

Evaporator anti-freezing protection, condenser high temperature protection and outdoor unit frequency limit are active and are the same as that in the cooling mode. The outdoor fan operates the same as in cooling mode.

### Forced Operation Function

- **Enter forced operation function:** When the machine is off, press **Touch** to engage the the Forced Auto Mode. Press **Touch** again, within 5 seconds, to engage the Forced Cooling Mode. In Forced Auto, forced cooling or any other operation mode, press the touch button to turn off the unit. In the forced operation mode, all general protections and remote control are available.

### Operation rules:

- **Forced cooling mode:** The compressor runs at the F2 frequency and the indoor fan runs as a breeze. After running for 30 minutes, the unit enters the auto mode as 75.2°F (24°C) setting temperature.
- **Forced auto mode:** The forced auto mode is the same as the normal auto mode with a 75.2°F (24°C) setting temperature.

### AUTO-RESTART Function

The indoor unit is equipped with the **AUTO-RESTART** function, which is carried out through an auto-restart module. In the event of a sudden power failure, the module memorizes the setting conditions prior to the power failure. The unit resumes the previous operation setting (not including the **SWING** function) automatically three (3) minutes after the power returns.

If the memorization condition is the **FORCED COOLING** mode, the unit will run in the **COOLING** mode for 30 minutes and turn to the **AUTO** mode at the 75.2°F(24°C) setting temperature.

If the air conditioner is off before the power turns off and the air conditioner is required to start up, the compressor delays start up for 1 minute before powering on. In other instances, the compressor waits three (3) minutes before restarts.

### Refrigerant Leak Detection

With this new technology, the display area displays “EC” when the outdoor unit detects a refrigerant leak. This function is only active in cooling mode. It can better prevent the compressor being damaged by refrigerant leakage or compressor overload.

Open Condition: When the compressor is active, the value of the Coil temperature of evaporator T2 has no change or very little change.

### 46°F (8°C) Heating

When the compressor is running, the indoor fan motor runs without the ANTI-COLD air function. When the compressor is off, the indoor fan motor is off.

### Point Check Function

Press the remote controller’s LED DISPLAY or LED or MUTE button three times, and then press the AIR DIRECTION or SWING button three times in ten seconds, the buzzer rings for two seconds. The air conditioner enters into the information enquiry status.

Press the LED DISPLAY or AIR DIRECTION button to check the next or front item’s information.

When the air conditioner enters the information enquiry status, it displays the code name in 2 seconds (see Table 9).

Table 9—Information Enquiry

ENQUIRY INFORMATION	DISPLAYING CODE	MEANING
T1	T1	T1 temp.
T2	T2	T2 temp.
T3	T3	T3 temp.
T4	T4	T4 temp.
T2B	Tb	T2B temp.
TP	TP	TP temp.
TH	TH	TH temp.
Targeted Frequency	FT	Targeted Frequency
Actual Frequency	Fr	Actual Frequency
Indoor Fan Speed	IF	Indoor fan speed
Outdoor Fan Speed	OF	Outdoor fan speed
EXV Opening Angle	LA	EXV opening angle
Compressor continuous running time	CT	Compressor continuous running time
Compressor stop causes	ST	Compressor stop causes
Reserve	A0	
Reserve	A1	
Reserve	b0	
Reserve	b1	
Reserve	b2	
Reserve	b3	
Reserve	b4	
Reserve	b5	
Reserve	bb	
Reserve	dL	
Reserve	Ac	
Reserve	Uo	
Reserve	Td	



When the air conditioner enters the information enquiry status, it displays the code value for 25 seconds (see Table 10).

**Table 10—Information Enquiry**

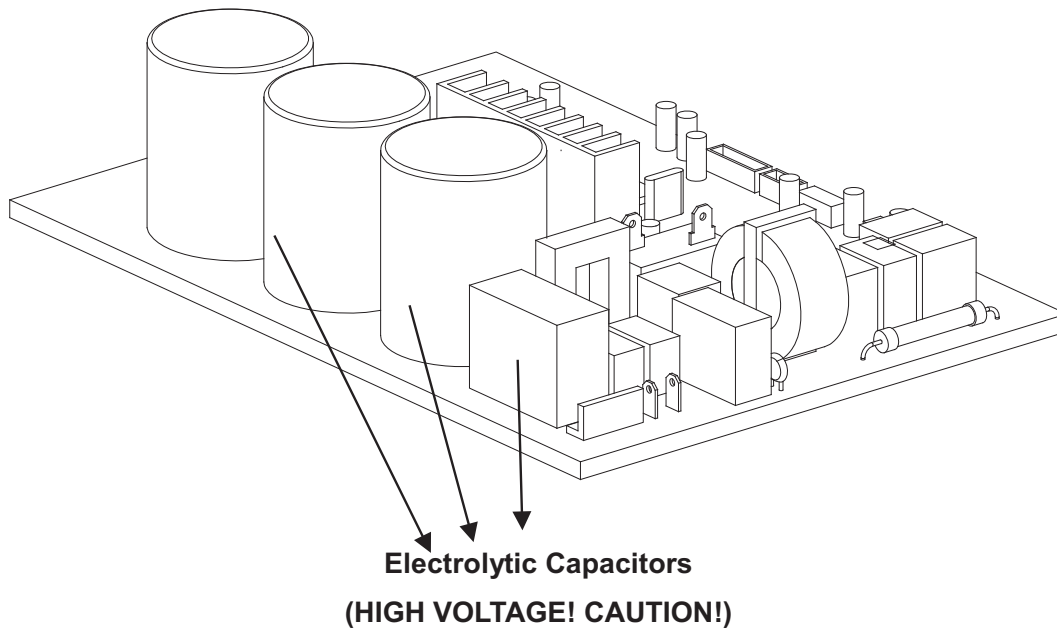
ENQUIRY INFORMATION	DISPLAY VALUE	MEANING	REMARK
T1,T2,T3,T4, T2B,TP,TH, Targeted Frequency, Actual Frequency	-1F,-1E,-1d,-1c, -1b,-1A	-25,-24,-23,-22,-21,-20	1. The displaying temperature is the actual value. 2. The temperature is °C no matter what kind of remote controller is used. 3. T1,T2,T3,T4,T2B display range: -25~70, TP display range: -20~130. 4. Frequency display range: 0~159HZ. 5. If the actual value exceeds the range, it displays the maximum value or minimum value.
	-19-99	-19-99	
	A0,A1,...A9	100,101,...109	
	b0,b1,...b9	110,111,...119	
	c0,c1,...c9	120,121,...129	
	d0,d1,...d9	130,131,...139	
	E0,E1,...E9	140,141,...149	
F0,F1,...F9	150,151,...159		
Indoor fan speed /Outdoor fan speed	0	OFF	
	1,2,3,4	Low speed, Medium speed, High speed, Turbo	For some big capacity motors.
	14-FF	Actual fan speed = Display value turns to decimal value and then multiply 10. The unit is RPM.	For some small capacity motors, the display value is from 14-FF (hexadecimal), the corresponding fan speed range is from 200-2550 RPM.
EXV opening angle	0-FF	Actual EXV opening value = Display value turns to decimal value and then multiply 2.	
Compressor continuous running time	0-FF	0-255 minutes	If the actual value exceeds the range, it displays the maximum value or minimum value.
Compressor stop causes	0-99	For the detailed meaning, please consult with engineer	Decimal display
Reserve	0-FF		

# TROUBLESHOOTING

## Safety

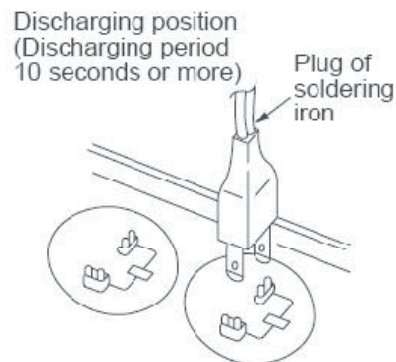
Electricity power is kept in capacitors even if the power supply is shut off.

**NOTE:** Remember to discharge the electricity power in capacitor.



**Fig. 25 – Electrolytic Capacitors**

For other models, please connect discharge resistance (approximately 100Ω 40W) or a soldering iron (plug) between the +, – terminals of the electrolytic capacitor on the contrary side of the outdoor PCB.



**Fig. 26 – Discharge Position**

**NOTE:** Fig. 26 is for reference only. The plug on your unit may differ.

# OUTDOOR UNIT DIAGNOSTIC GUIDES

Table 11—Diagnostic Guides

OPERATION LAMP	TIMER LAMP	DISPLAY	LED STATUS
☆ 1 time	X	E0	Indoor unit EEPROM parameter error
☆ 2 times	X	E1	Indoor / outdoor units communication error
☆ 3 times	X	E2	Zero-crossing signal detection error
☆ 4 times	X	E3	Indoor fan speed has been out of control
☆ 5 times	X	E4	Indoor room temperature sensor T1 open circuit or short circuit
☆ 6 times	X	E5	Evaporator coil temperature sensor T2 open circuit or short circuit
☆ 7 times	X	EC	Refrigerant leakage detection
☆ 1 time	O	F0	Overload current protection
☆ 2 times	O	F1	Outdoor ambient temperature sensor T4 open circuit or short circuit
☆ 3 times	O	F2	Condenser coil temperature sensor T3 open circuit or short circuit
☆ 4 times	O	F3	Compressor discharge temperature sensor T5 open circuit or short circuit
☆ 5 times	O	F4	Outdoor unit EEPROM parameter error
☆ 6 times	O	F5	Outdoor fan speed has been out of control
☆ 1 time	☆	P0	IPM malfunction or IGBT over-strong current protection
☆ 2 times	☆	P1	Over voltage or over low voltage protection
☆ 3 times	☆	P2	High temperature protection of IPM module or compressor top
☆ 4 times	☆	P3*	Outdoor ambient temperature too low.
☆ 5 times	☆	P4	Inverter compressor drive error
☆ 6 times	☆	P5	Indoor units mode conflict (multi-zone ONLY)

O (light)    X (off)    ☆ (flash)

# PCB DIAGRAMS

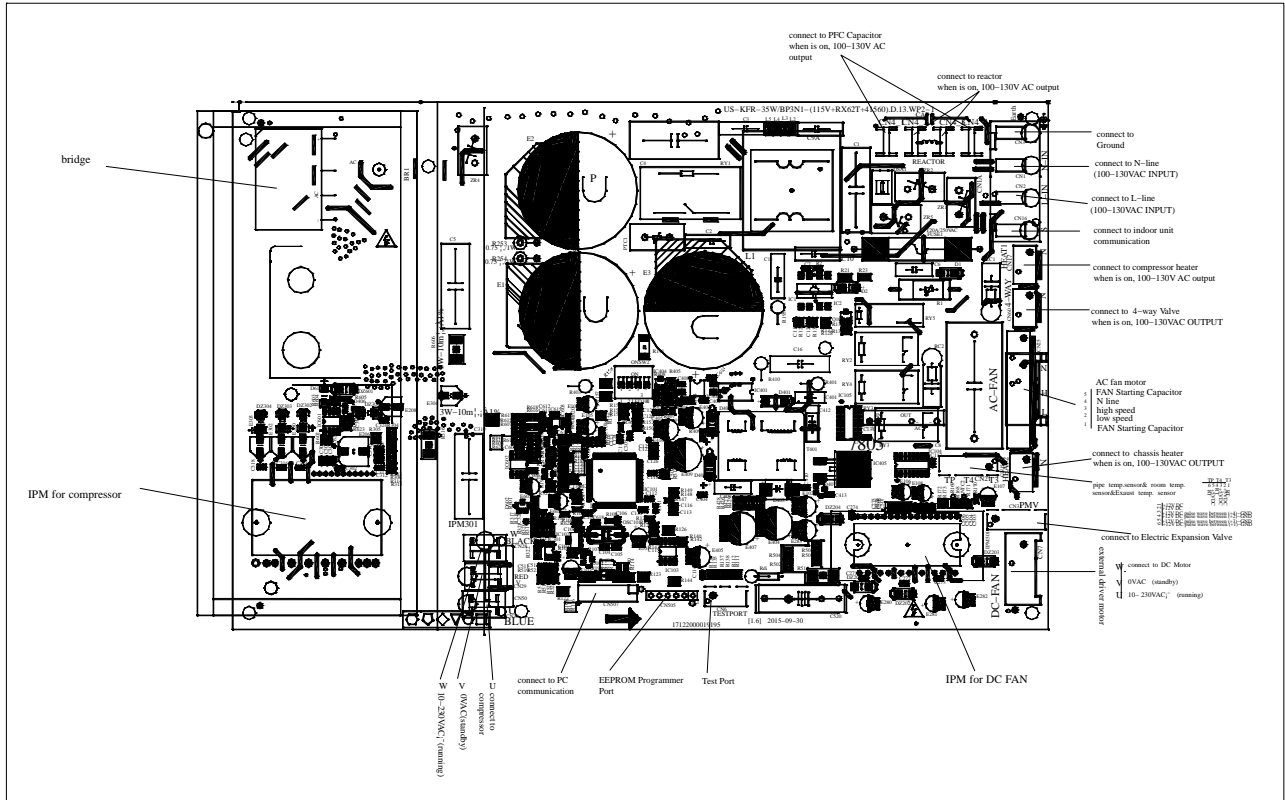


Fig. 27 – Size 12k (115V)

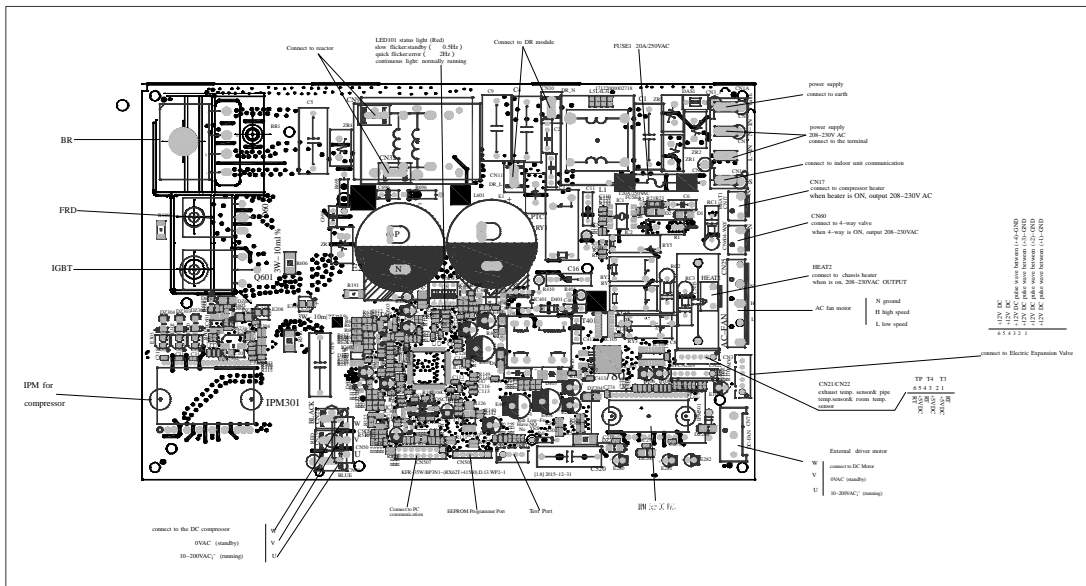


Fig. 28 – Size 09k-12k (208-230V)

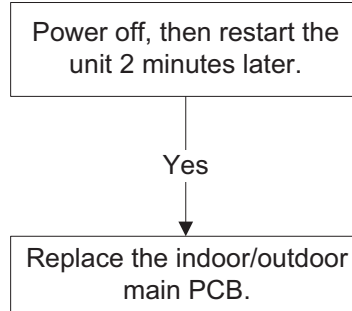


# DIAGNOSIS AND SOLUTION

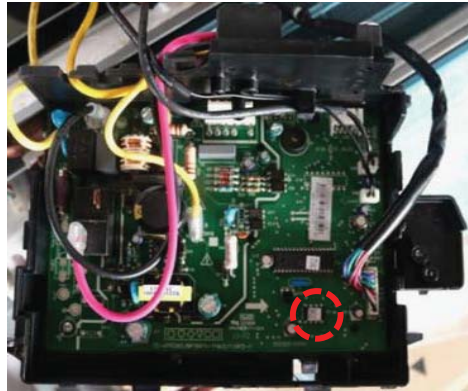
## EEPROM Parameter Error Diagnosis and Solution (E0/F4)

Error Code	E0/F4
Malfunction decision conditions	Indoor or outdoor PCB main chip does not receive feedback from the EEPROM chip.
Supposed causes	<ul style="list-style-type: none"><li>• Installation mistake</li><li>• PCB faulty</li></ul>

### Troubleshooting



**EEPROM:** A read-only memory whose contents can be erased and reprogrammed using a pulsed voltage. For the EEPROM chip location, please refer to Fig 30 and Fig. 31.



**Fig. 30 – Indoor PCB**



**Fig. 31 – Outdoor PCB**

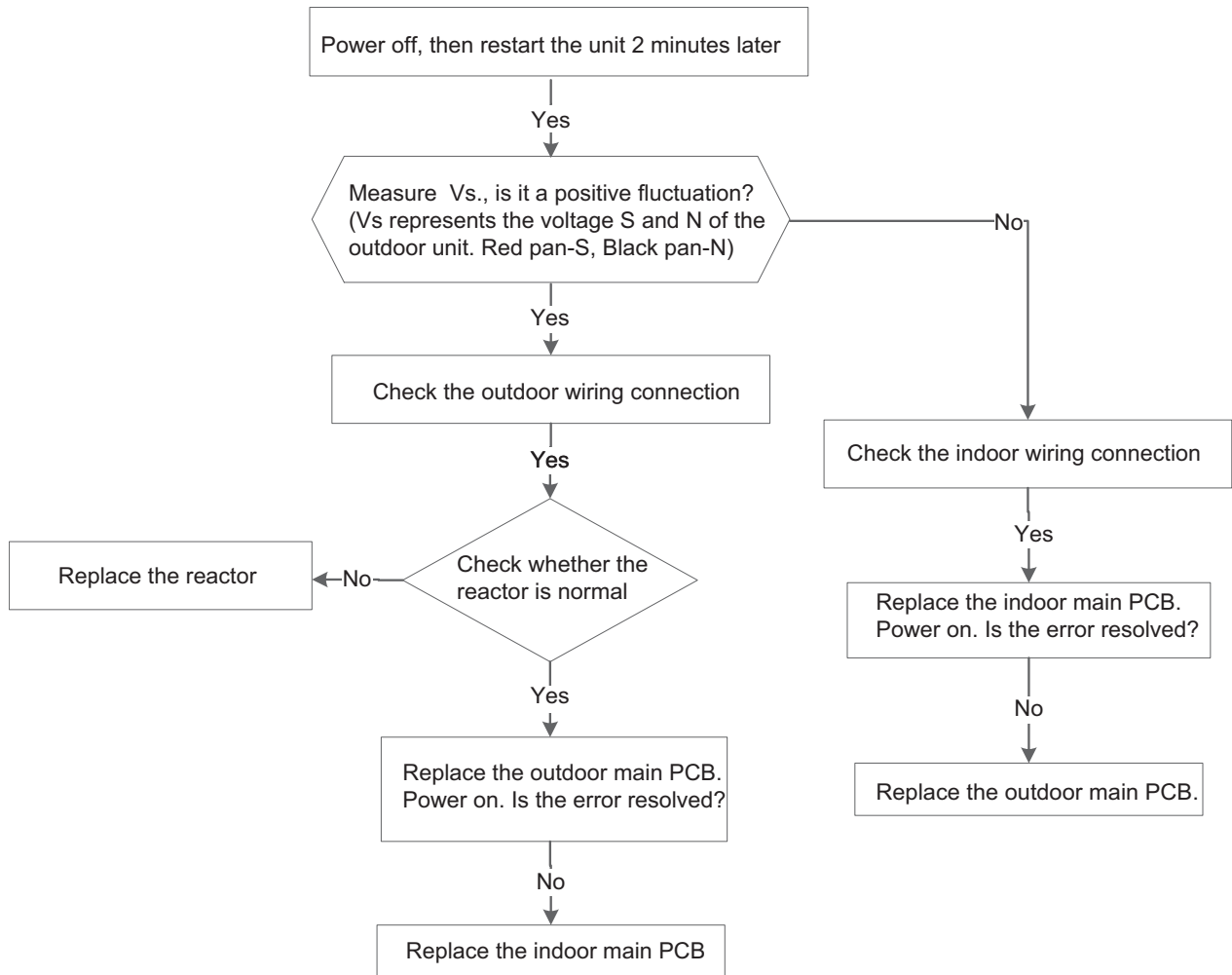
**NOTE:** The two pictures above are for reference only and they may differ from the actual unit.

# DIAGNOSIS AND SOLUTION (CONT)

## Indoor / outdoor unit's communication diagnosis and solution (E1)

Error Code	E1
Malfunction Decision Conditions	Indoor unit does not receive the feedback from outdoor unit during 110 seconds and this condition happens four times continuously.
Supposed Causes	<ul style="list-style-type: none"> <li>Wiring mistake</li> <li>Indoor or outdoor PCB faulty</li> </ul>

### Troubleshooting



## DIAGNOSIS AND SOLUTION (CONT)



**Fig. 32 – Test the DC Voltage**

Use a multimeter to test the DC voltage between L2 port and S port of the outdoor unit. The red pin of the multimeter connects with the L2 port while the black pin is for the S port. When air conditioner is running normal, the voltage moves alternately between  $-50V$  to  $50V$ . If the outdoor unit has a malfunction, the voltage will move alternately with positive value. If the indoor unit has malfunction, the voltage will have a certain value.



**Fig. 33 – Test the Reactor Resistance**

Use a multimeter to test the resistance of the reactor which does not connect with the capacitor. The normal value should be around zero (0) ohm. Otherwise, the reactor has a malfunction and needs to be replaced.

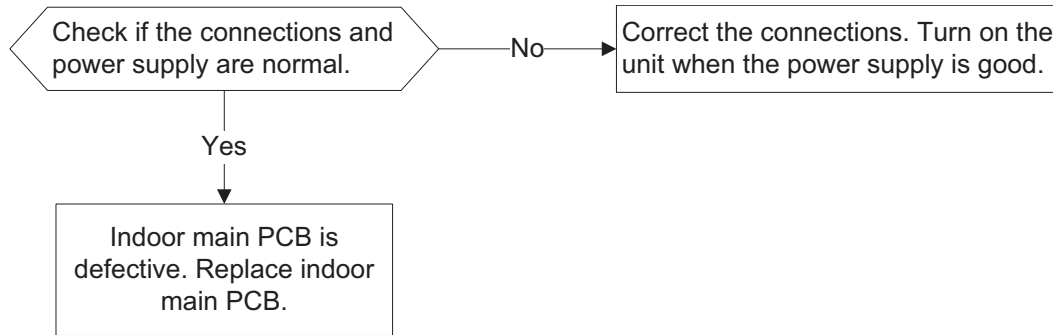


# DIAGNOSIS AND SOLUTION (CONT)

## Zero crossing detection error diagnosis and solution (E2)

Error Code	E2
Malfunction decision conditions	When the PCB does not receive a zero crossing signal feedback for 4 minutes or the zero crossing signal time interval is abnormal.
Supposed causes	<ul style="list-style-type: none"><li>• Connection mistake</li><li>• PCB faulty</li></ul>

### Troubleshooting

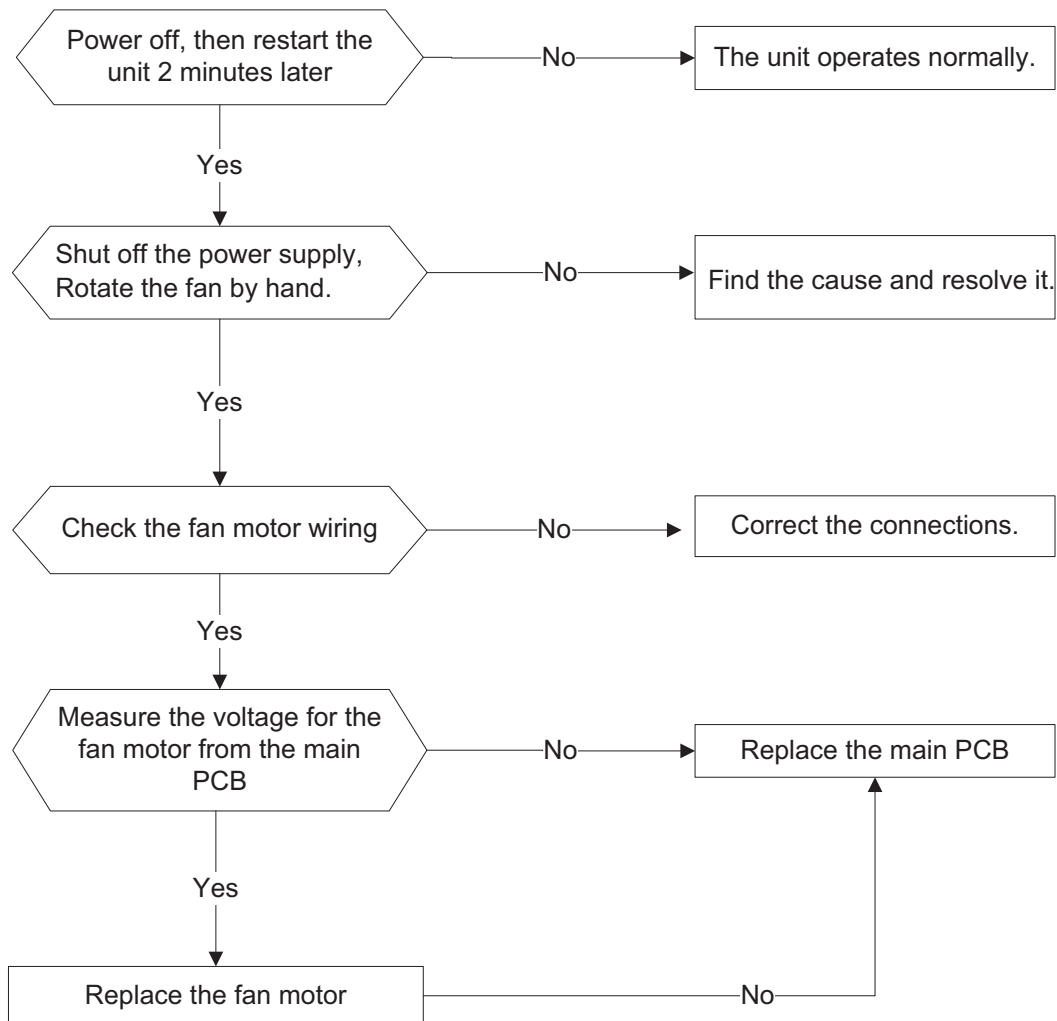


## DIAGNOSIS AND SOLUTION (CONT)

### Fan speed has been out of control diagnosis and solution (E3/F5)

Error Code	E3/F5
Malfunction decision conditions	When indoor fan speed remains too low (300RPM) for certain time, the unit stops and the LED displays the failure.
Supposed causes	<ul style="list-style-type: none"> <li>• Wiring mistake</li> <li>• Fan assembly faulty</li> <li>• Fan motor faulty</li> <li>• PCB faulty</li> </ul>

#### Troubleshooting



# DIAGNOSIS AND SOLUTION (CONT)

## Index 1

1. Indoor or Outdoor DC Fan Motor (control chip is in fan motor)

- Power on and when the unit is in standby, measure the voltage of pin1–pin3, pin4–pin3 in fan motor connector. If the voltage value is not in the range shown in Table 13 or Table 14, the PCB has an issue and needs to be replaced.

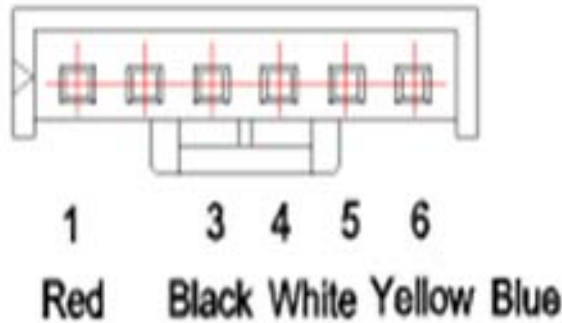


Fig. 34 – Motor Connector

Table 13—DC motor voltage input and output (voltage: 220–240V~)

NO.	COLOR	SIGNAL	VOLTAGE
1	Red	Vs/Vm	280V~380V
2	---	---	---
3	Black	GND	0V
4	White	Vcc	14–17.5V
5	Yellow	Vsp	0~5.6V
6	Blue	FG	14–17.5V

Table 14—DC motor voltage input and output (voltage : 115V~)

NO.	COLOR	SIGNAL	VOLTAGE
1	Red	Vs/Vm	140V~190V
2	---	---	---
3	Black	GND	0V
4	White	Vcc	14–17.5V
5	Yellow	Vsp	0~5.6V
6	Blue	FG	14–17.5V

2. Outdoor DC Fan Motor (control chip is in the outdoor PCB)

Power on the unit and check if the fan runs normally. If the fan runs normally, the PCB has an issue and needs to be replaced. If the fan does not run normally, measure the resistance of each two pins. If the resistance is not equal to each other, the fan motor has an issue and needs to be replaced, otherwise the PCB has an issue and needs to be replaced.

3. Indoor AC Fan Motor

Power on the unit and set the unit in **FAN** mode at the high fan speed. Run for 15 seconds then measure the voltage of pin1 and pin2. If the voltage value is less than 100V(208~240V power supply) or 50V(115V power supply), the PCB has an issue and needs to be replaced.

## DIAGNOSIS AND SOLUTION (CONT)

### Open circuit or short circuit of temperature sensor diagnosis and solution (E4/E5/F1/F2/F3)

Error Code	E4/E5/F1/F2/F3
Malfunction decision conditions	If the sampling voltage is lower than 0.06V or higher than 4.94V, the LED displays the failure.
Supposed causes	<ul style="list-style-type: none"><li>• Wiring mistake</li><li>• Sensor faulty</li><li>• PCB faulty</li></ul>

#### Troubleshooting

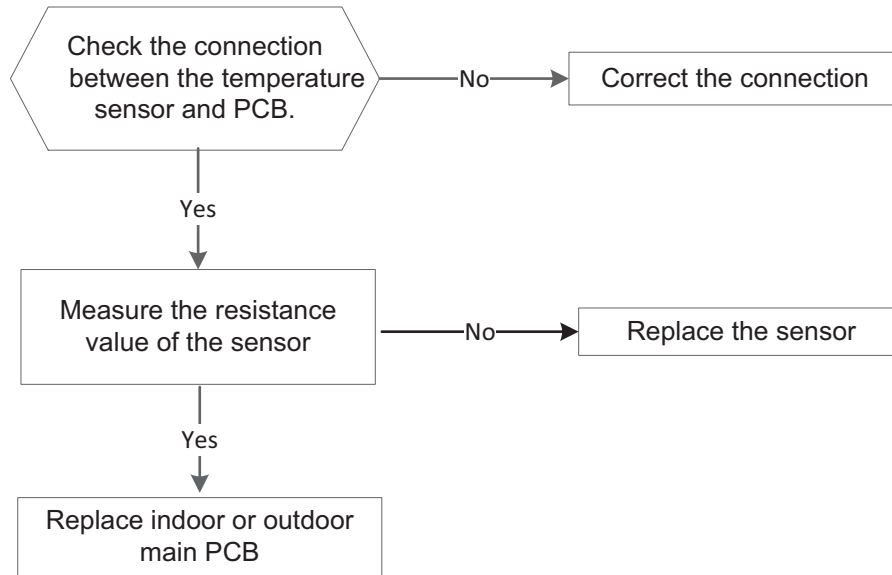


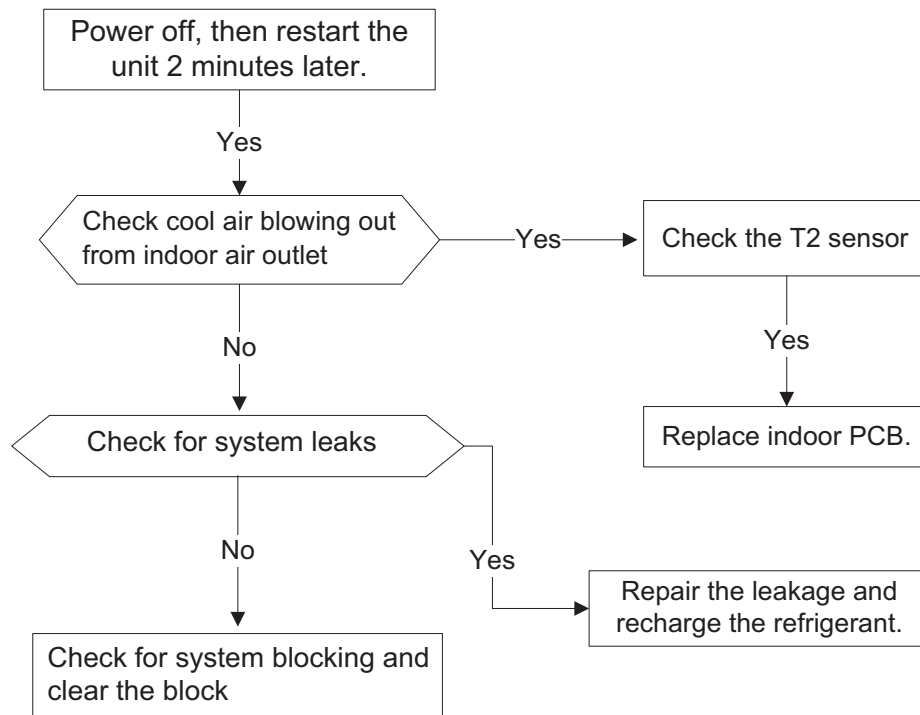
Fig. 35 – Check the connection

# DIAGNOSIS AND SOLUTION (CONT)

## Refrigerant Leakage Detection diagnosis and solution (EC)

Error Code	EC
Malfunction decision conditions	Define the evaporator coil temp.T2 of the compressor. It starts running in Tcool. At first, 5 minutes after the compressor starts up, if $T2 < T_{cool} - 35.6^{\circ}\text{F}$ ( $T_{cool} - 2^{\circ}\text{C}$ ) does not run for 4 seconds and this situation occurs 3 times, the display area displays "EC" and the air conditioner will turn off.
Supposed causes	<ul style="list-style-type: none"> <li>• T2 sensor faulty</li> <li>• Indoor PCB faulty</li> <li>• System problems, such as leakage or blocking.</li> </ul>

### Troubleshooting

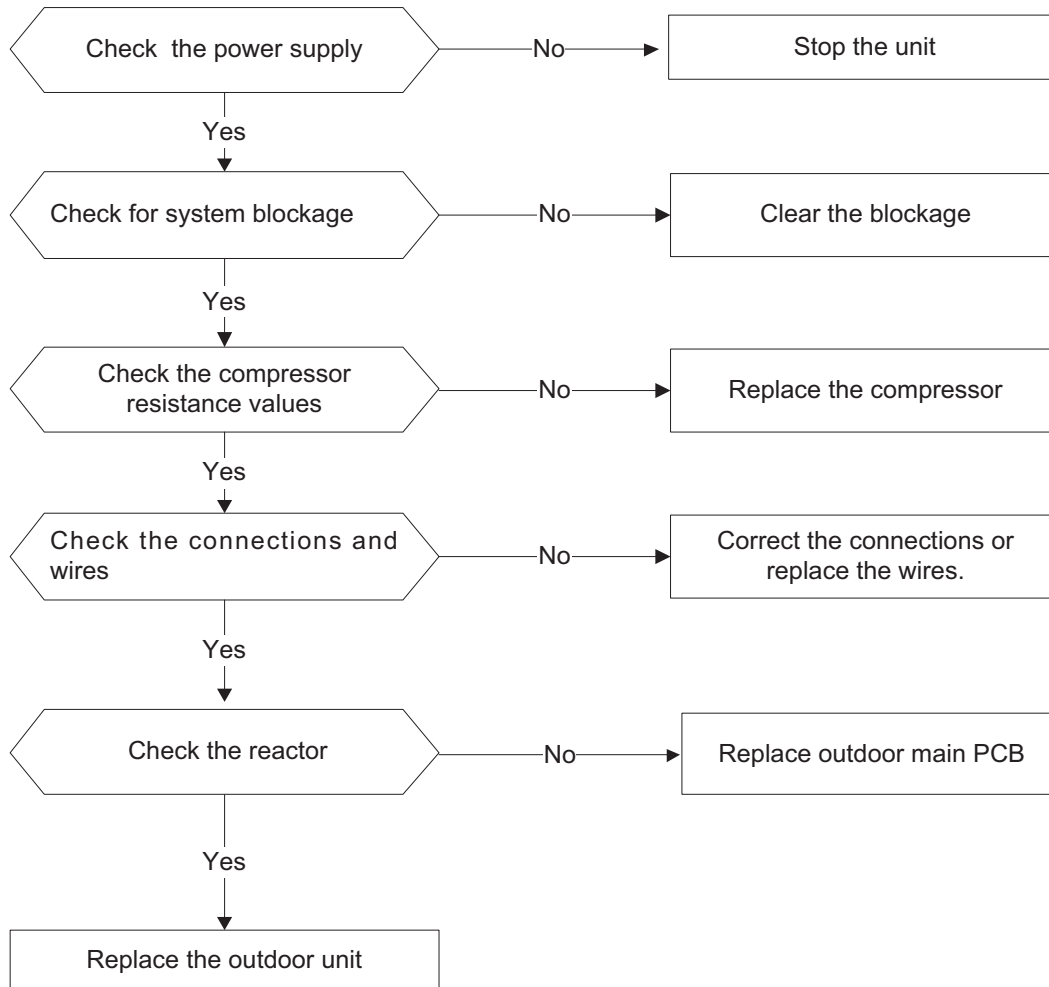


## DIAGNOSIS AND SOLUTION (CONT)

### Overload current protection diagnosis and solution (F0)

Error Code	F0
Malfunction decision conditions	An abnormal current rise is detected by checking the specified current detection circuit.
Supposed causes	<ul style="list-style-type: none"> <li>• Power supply problems</li> <li>• System blockage</li> <li>• PCB faulty</li> <li>• Wiring mistake</li> <li>• Compressor malfunction</li> </ul>

#### Troubleshooting

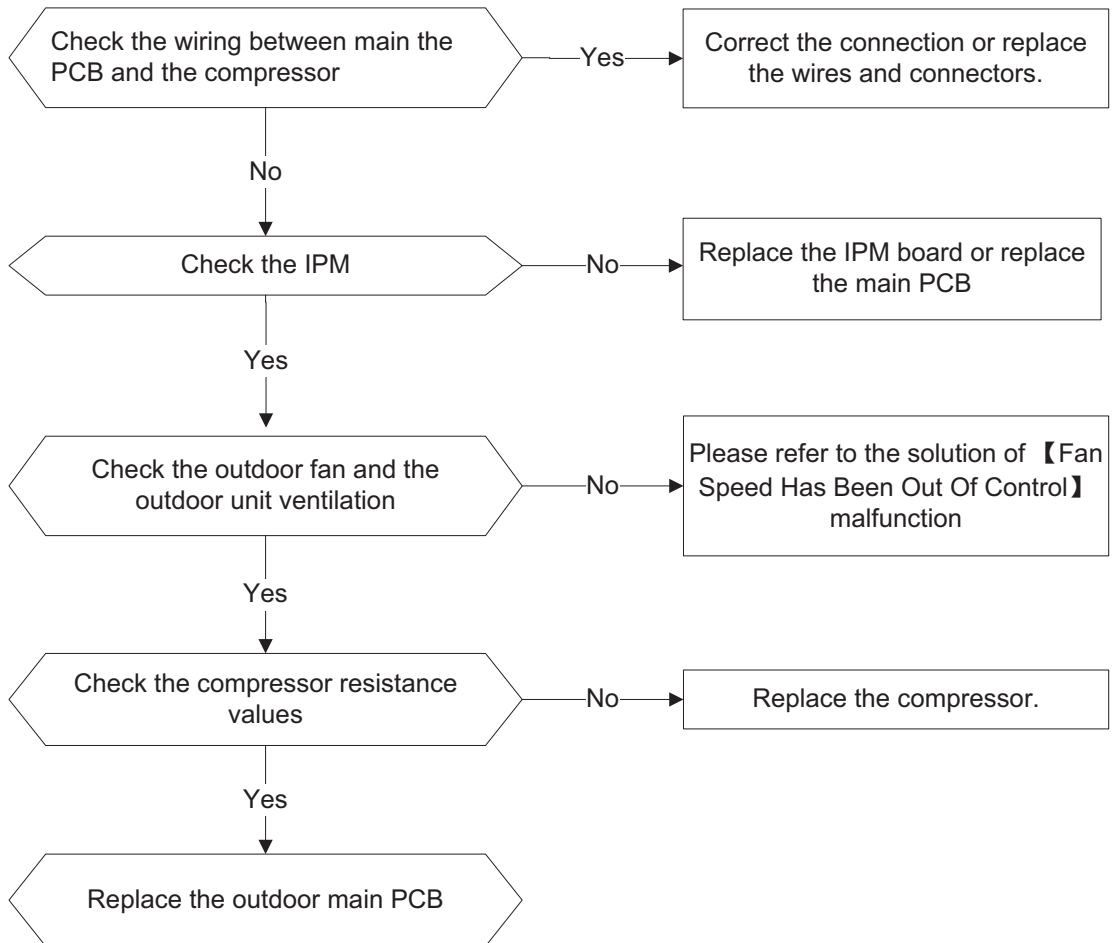


# DIAGNOSIS AND SOLUTION (CONT)

## IPM malfunction or IGBT over–strong current protection diagnosis and solution (P0)

Error Code	P0
Malfunction decision conditions	When the voltage signal, that the IPM sends to the compressor drive chip is abnormal, the display LED displays P0” and the air conditioner turns off.
Supposed causes	<ul style="list-style-type: none"> <li>• Wiring mistake</li> <li>• IPM malfunction</li> <li>• Outdoor fan assembly faulty</li> <li>• Compressor malfunction</li> <li>• Outdoor PCB faulty</li> </ul>

### Troubleshooting





## DIAGNOSIS AND SOLUTION (CONT)

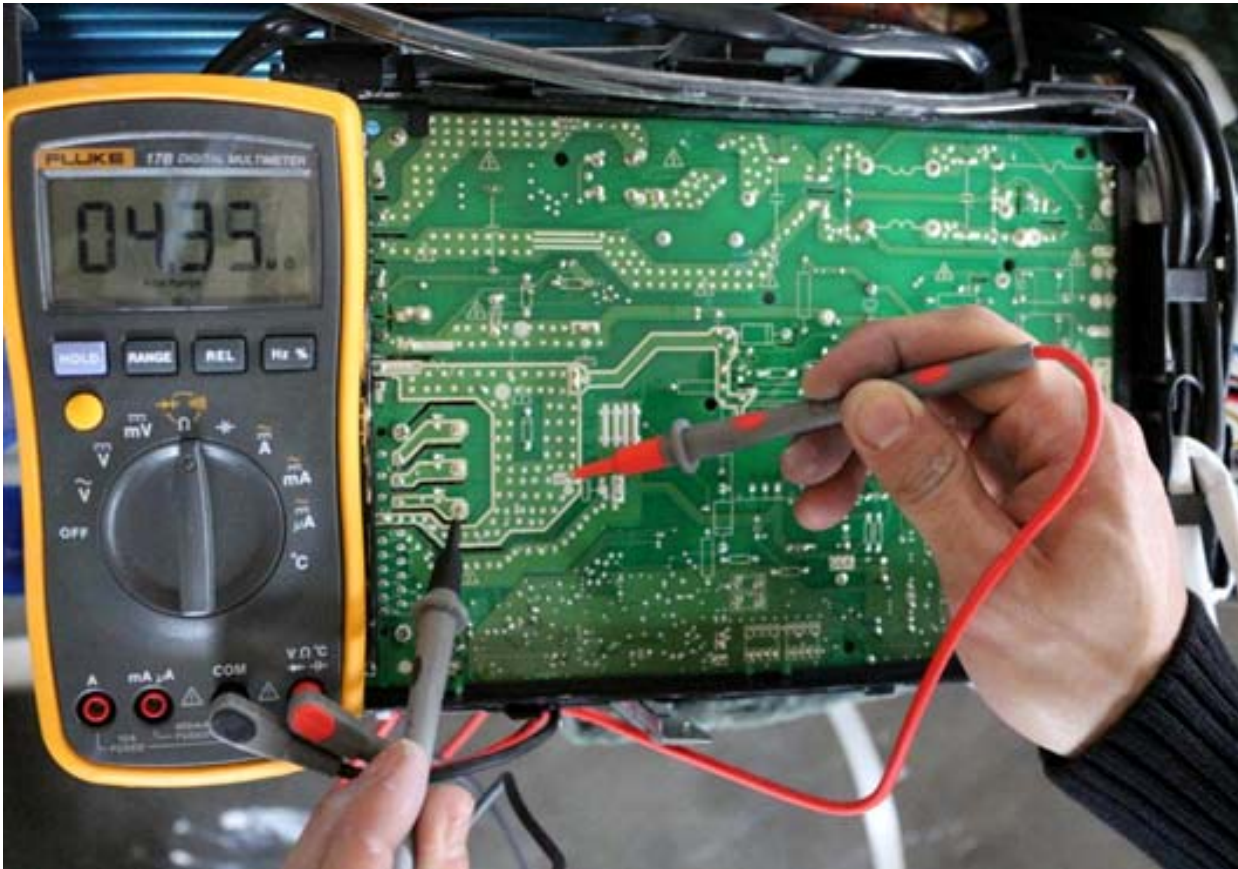


Fig. 36 – P-U

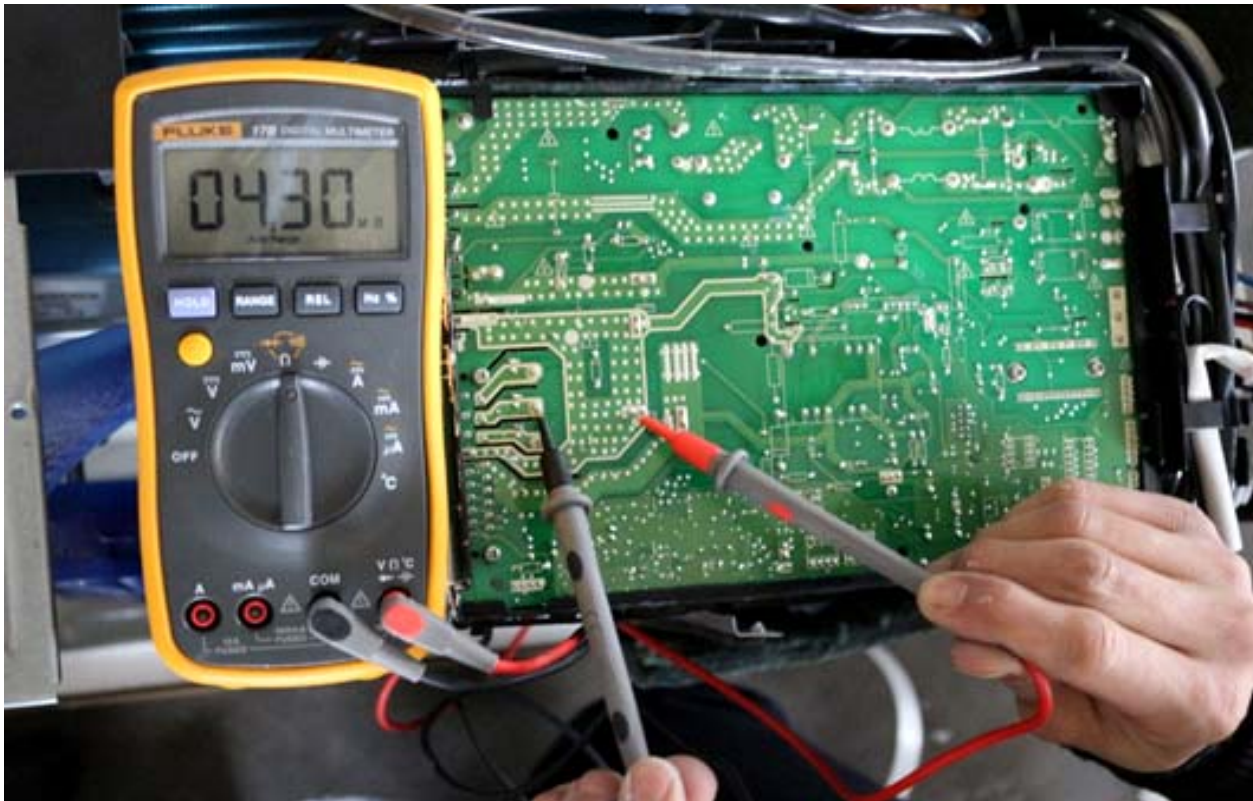


Fig. 37 – P-V



## DIAGNOSIS AND SOLUTION (CONT)

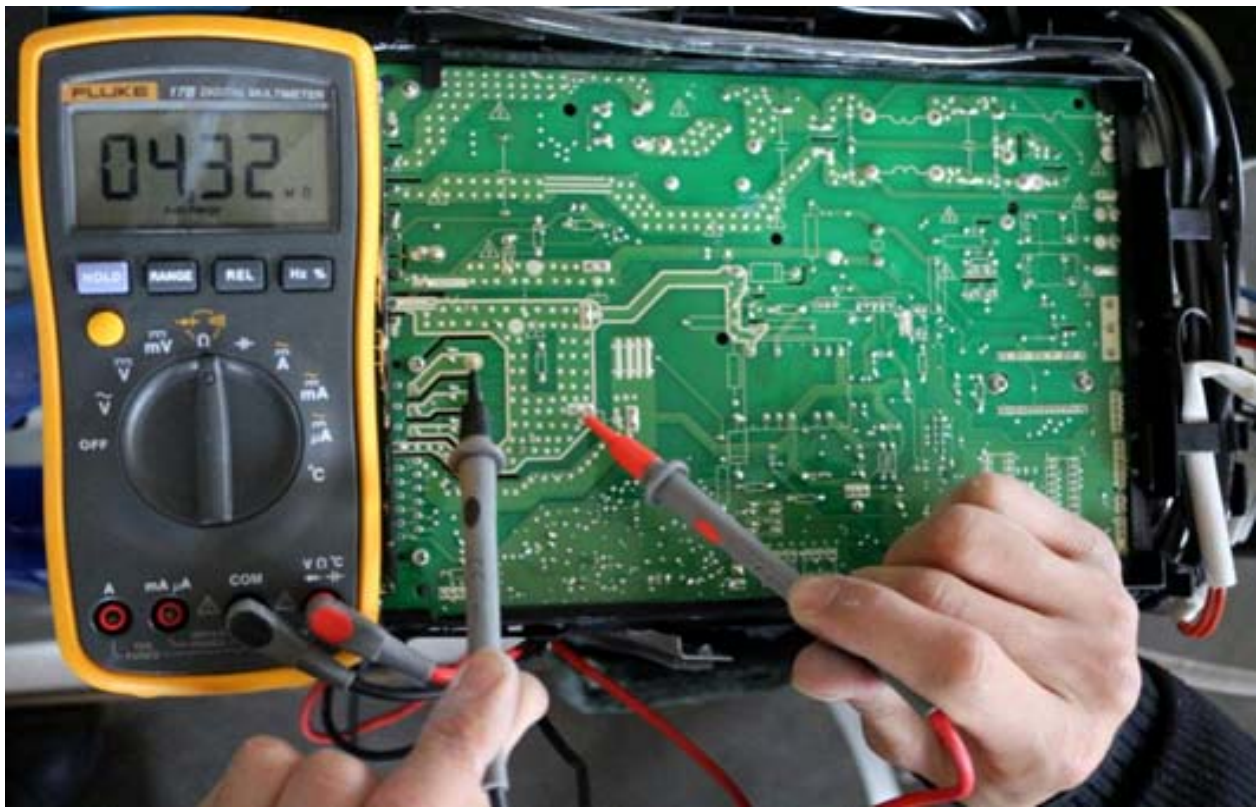


Fig. 38 – P-W

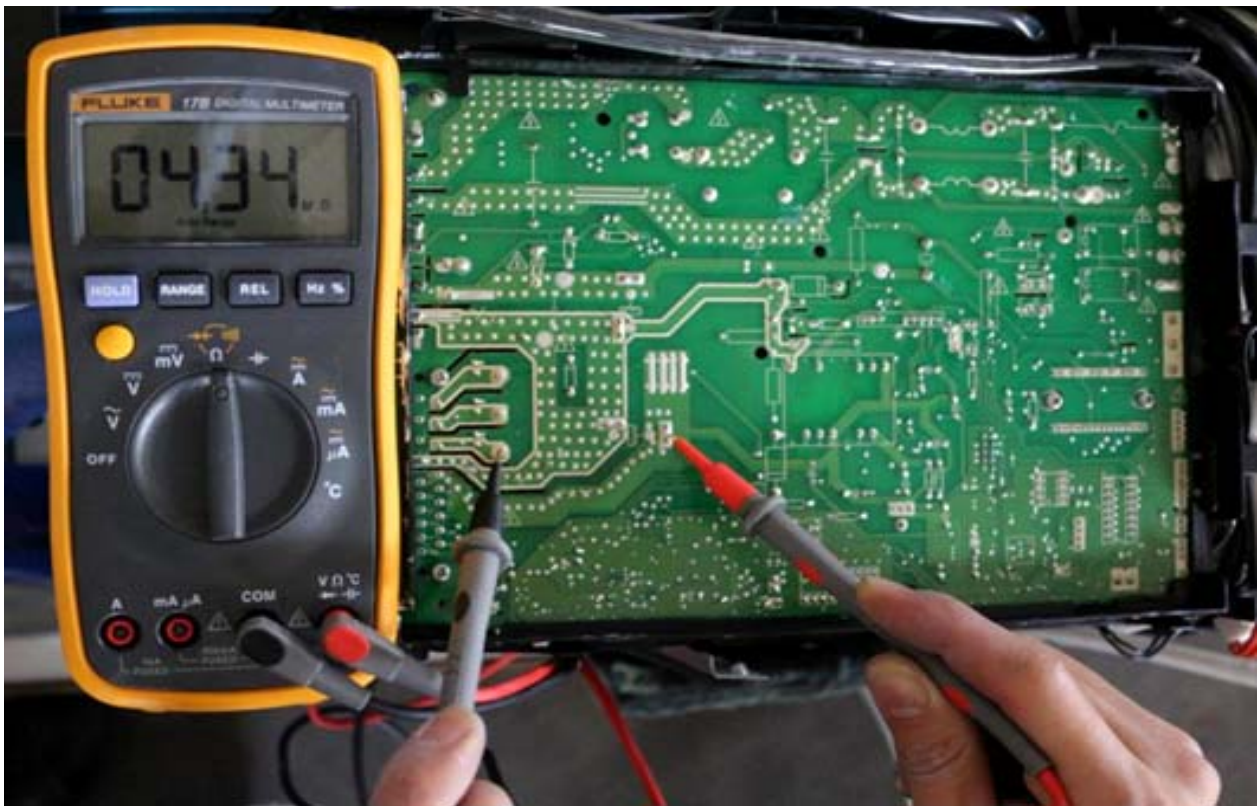


Fig. 39 – N-U



## DIAGNOSIS AND SOLUTION (CONT)

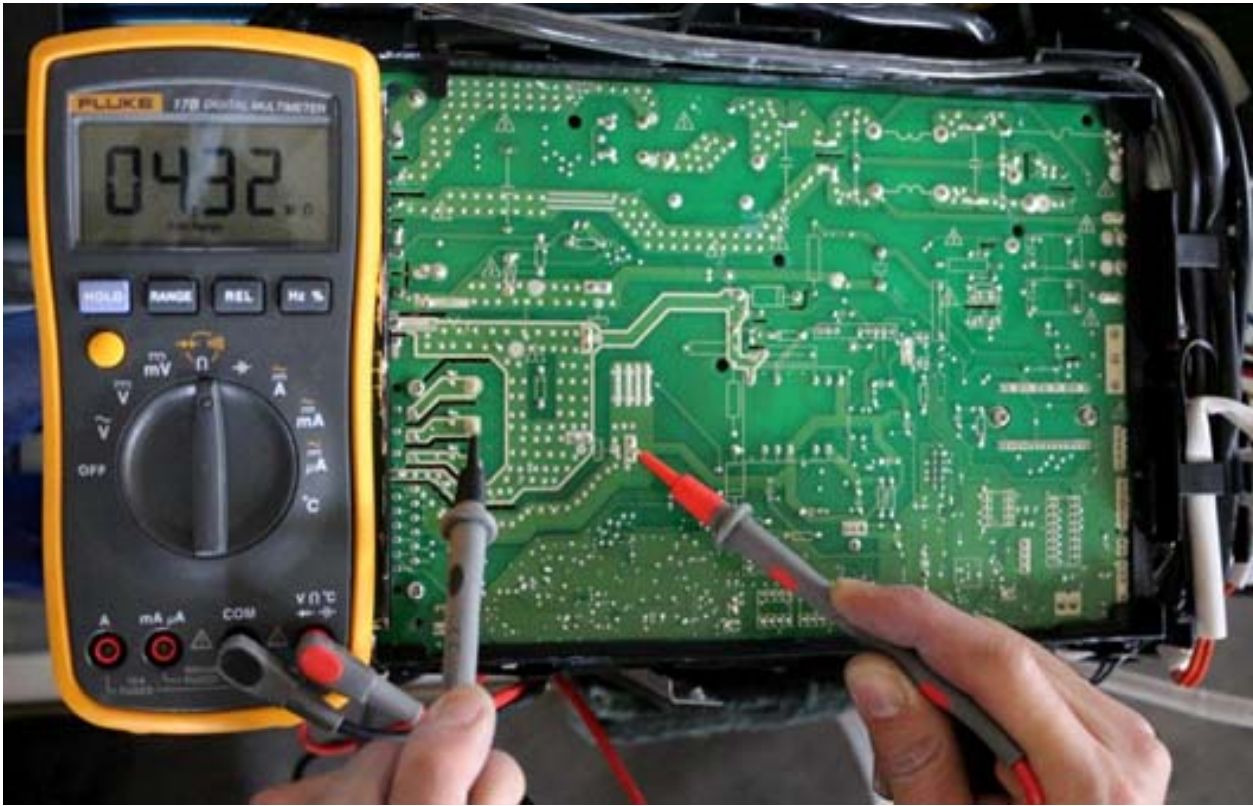


Fig. 40 – N-V

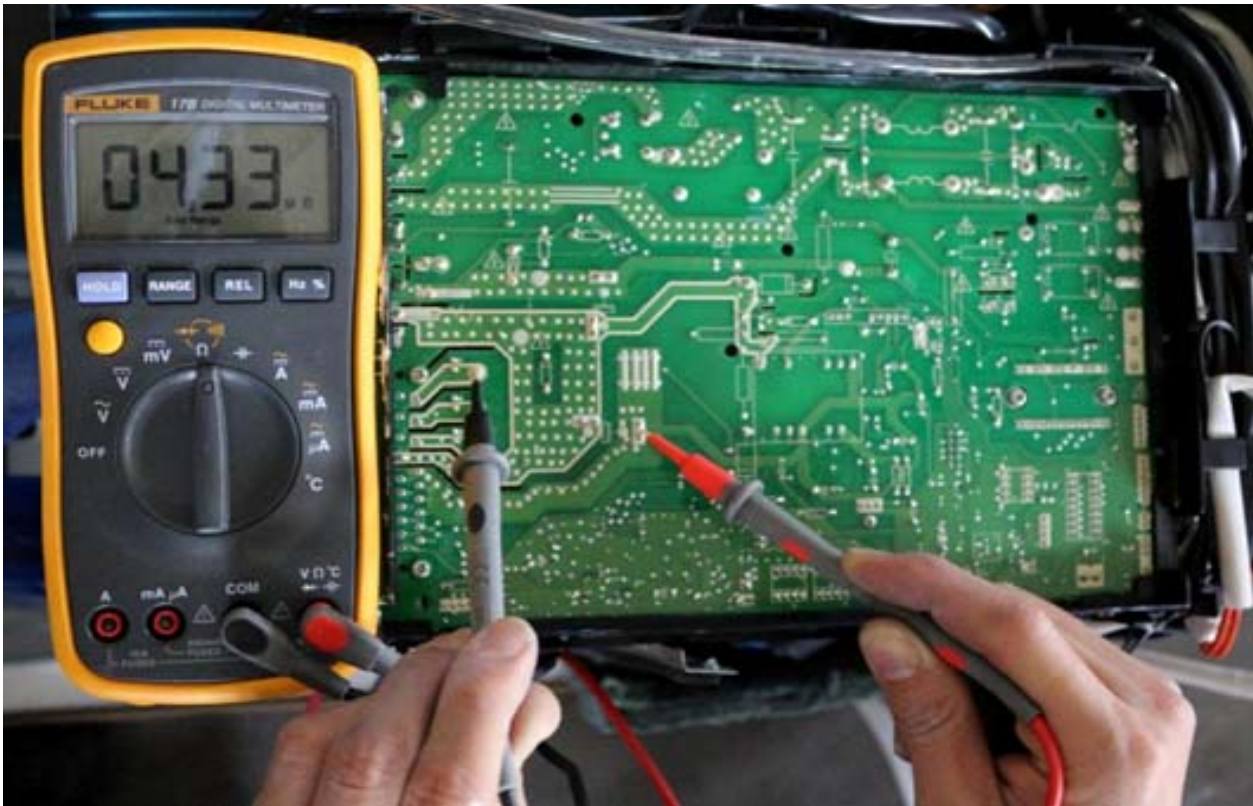


Fig. 41 – N-W

# DIAGNOSIS AND SOLUTION (CONT)

## Over voltage or too low voltage protection diagnosis and solution (P1)

Error Code	P1
Malfunction decision conditions	An abnormal voltage rise or drop is detected by checking the specified voltage detection circuit.
Supposed causes	<ul style="list-style-type: none"> <li>• Power supply problems</li> <li>• System leakage or block</li> <li>• PCB faulty</li> </ul>

### Troubleshooting

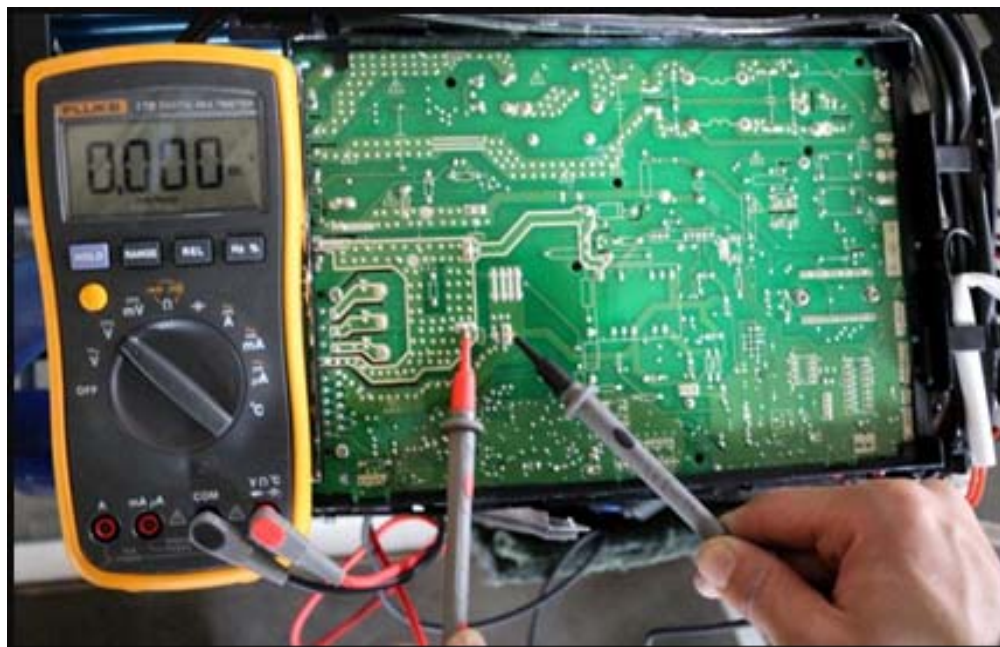
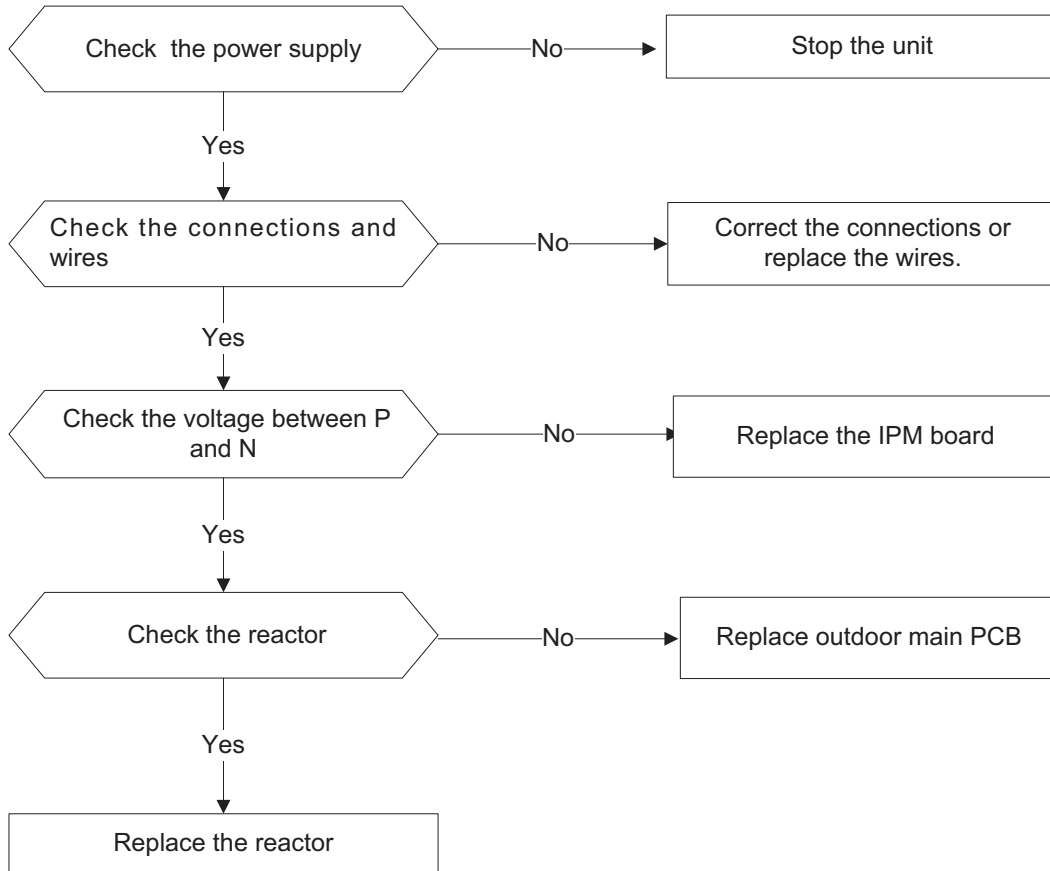


Fig. 42 – Test

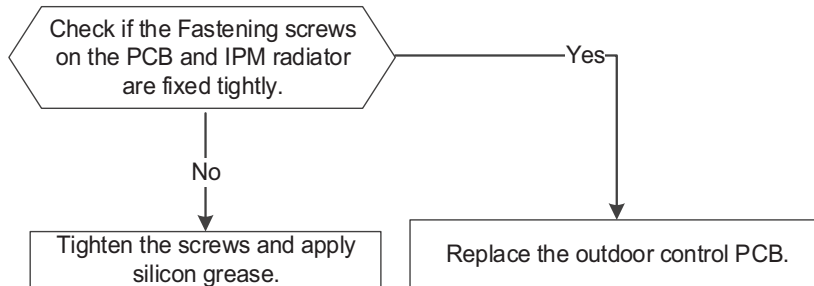
NOTE: Measure the DC voltage between the P and N port. The normal value should be around 310V.

## DIAGNOSIS AND SOLUTION (CONT)

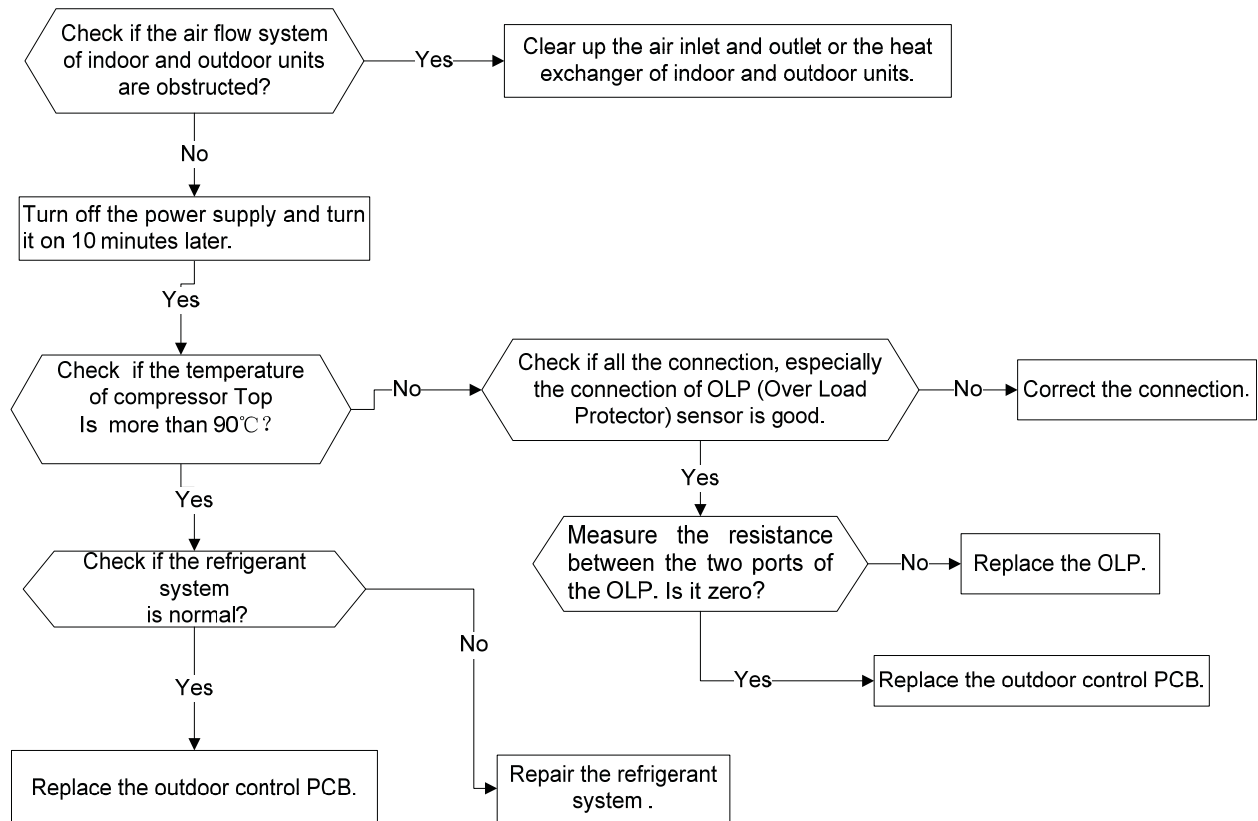
### High temperature protection of compressor top diagnosis and solution (P2)

Error Code	P2
Malfunction decision conditions	If the sampling voltage is not 5V, the LED displays the failure.
Supposed causes	<ul style="list-style-type: none"> <li>• Power supply problems</li> <li>• System leakage or block</li> <li>• PCB faulty</li> </ul>

#### Troubleshooting



#### For other models,

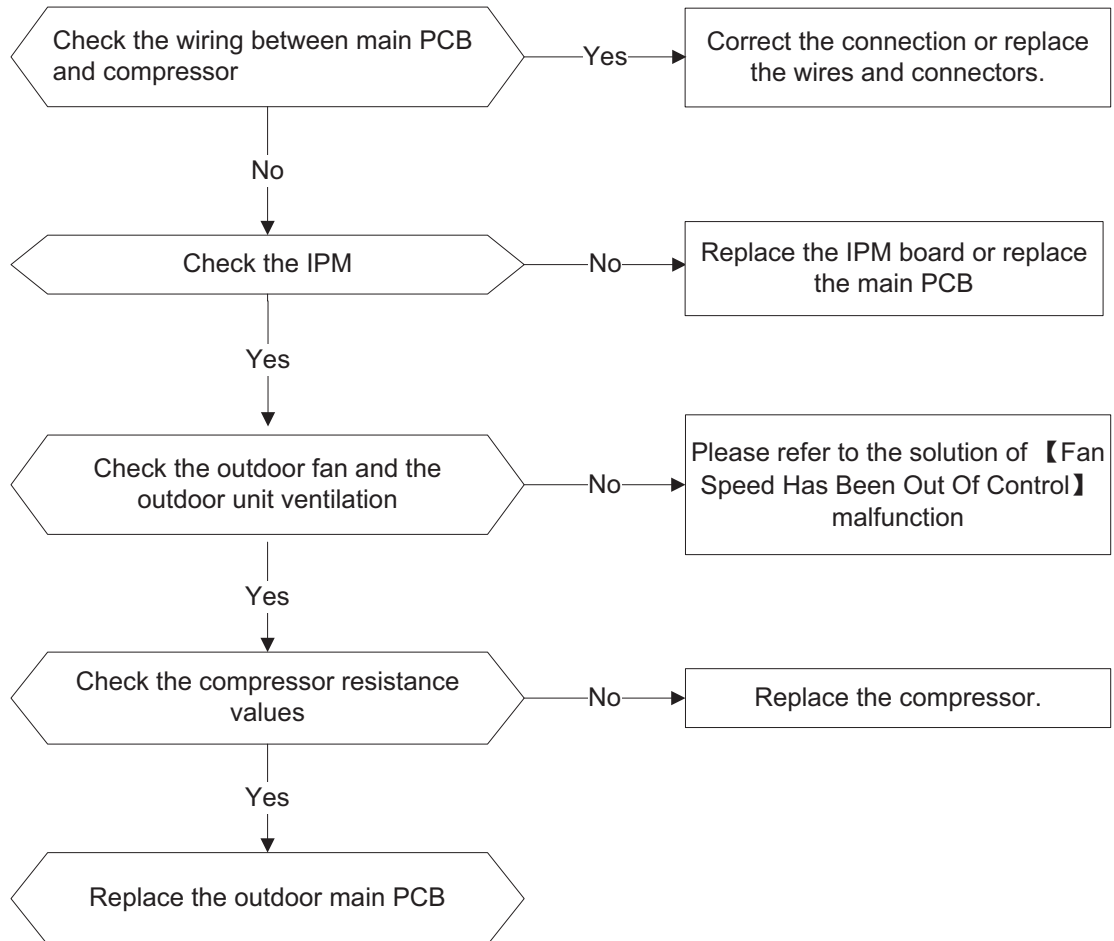


# DIAGNOSIS AND SOLUTION (CONT)

## Inverter compressor drive error diagnosis and solution (P4)

Error Code	P4
Malfunction decision conditions	An abnormal inverter compressor drive is detected by a special detection circuit, including communication signal detection, voltage detection, compressor rotation speed signal detection, etc.
Supposed causes	<ul style="list-style-type: none"> <li>• Wiring mistake</li> <li>• IPM malfunction</li> <li>• Outdoor fan assembly faulty</li> <li>• Compressor malfunction</li> <li>• Outdoor PCB faulty</li> </ul>

### Troubleshooting



## DIAGNOSIS AND SOLUTION (CONT)

### Main Parts Check

#### Temperature Sensor Checking

Disconnect the temperature sensor from the PCB, measure the resistance value with a tester.

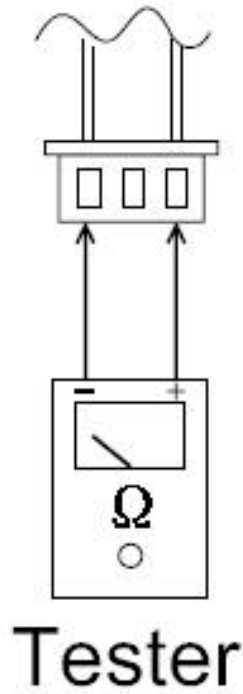


Fig. 43 – Tester

Temperature sensors.

Room temp.(T1) sensor,

Indoor coil temp.(T2) sensor,

Outdoor coil temp.(T3) sensor,

Outdoor ambient temp.(T4) sensor,

Compressor discharge temp.(T5) sensor.

Measure the resistance value of each winding by using the multi-meter.



# DIAGNOSIS AND SOLUTION (CONT)

## Compressor Checking

Measure the resistance value of each winding by using the tester.

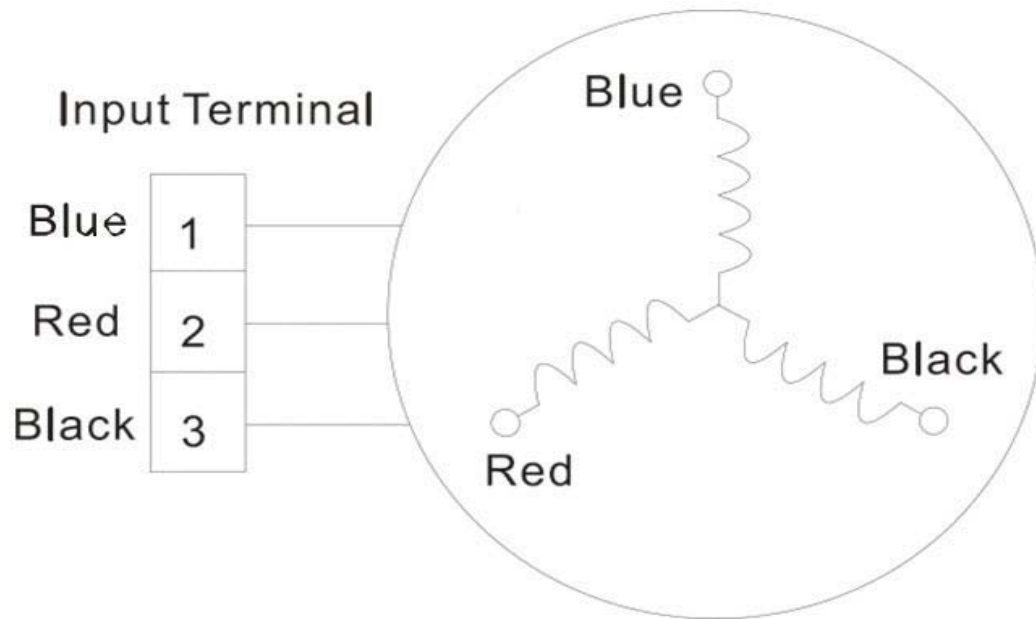


Fig. 44 – Tester

Table 15—Compressor Checking

Position	Resistance Value			
	ASN98D22UFZ	ASM135D23UFZ	ATF235D22UMT	ATF250D22UMT
Blue – Red	1.57Ω	1.75 Ω	0.75 Ω	0.75 Ω
Blue – Black				
Red – Blue				



Fig. 45 – Compressor Checking

## DIAGNOSIS AND SOLUTION (CONT)

### IPM Continuity Check

Turn off the power, let the large capacity electrolytic capacitors discharge completely, and dismount the IPM. Use a digital tester to measure the resistance between P and UVWN; UVW and N.

**Table 16—IPM Continuity Check**

Digital Tester		Normal Resistance Value	Digital Tester		Normal Resistance Value
(+)Red	(-)Black		(+)Red	(-)Black	
P	N	$\infty$ (Several M $\Omega$ )	U	N	$\infty$ (Several M $\Omega$ )
	U				
	V				
	W				
	W				
			(+)Red		

### Fan Motor

Measure the resistance value of each winding by using the tester.

**Table 17—Fan Motor**

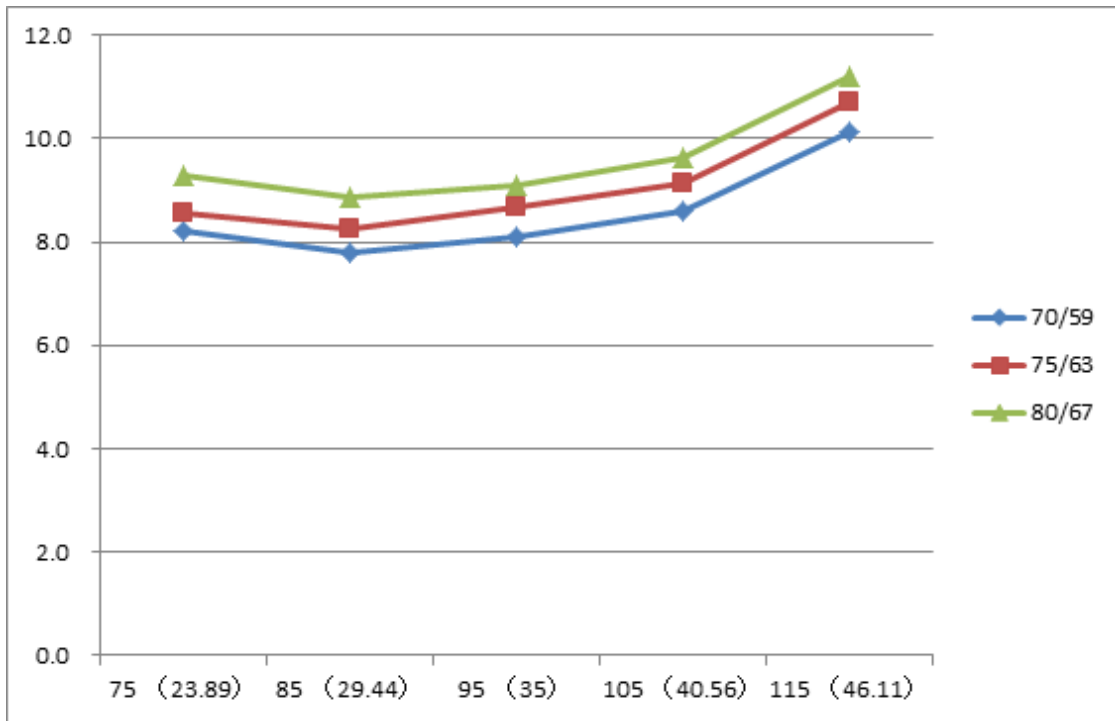
Model		YKT-32-6-202L	YKT-32-6-3L	YKT-48-6-206	YKT-63-6-200L
Brand		Tongde	Welling	Welling	Welling
Black - Red Main	$\Omega$	86	213	152	88.5
Blue -Black AUX	$\Omega$	64	156	142	138



**Pressure on Service Port**

**Table 18—Cooling Chart**

°F (°C)	ODT/IDT	75 (23.89)	85 (29.44)	95 (35)	105 (40.56)	115 (46.11)
BAR	70/59	8.2	7.8	8.1	8.6	10.1
BAR	75/63	8.6	8.3	8.7	9.1	10.7
BAR	80/67	9.3	8.9	9.1	9.6	11.2
°F (°C)	ODT/IDT	75 (23.89)	85 (29.44)	95 (35)	105 (40.56)	115 (46.11)
PSI	70/59	119	113	117	125	147
PSI	75/63	124	120	126	132	155
PSI	80/67	135	129	132	140	162
°F (°C)	ODT/IDT	75 (23.89)	85 (29.44)	95 (35)	105 (40.56)	115 (46.11)
MPA	70/59	0.82	0.78	0.81	0.86	1.01
MPA	75/63	0.86	0.83	0.87	0.91	1.07
MPA	80/67	0.93	0.89	0.91	0.96	1.12

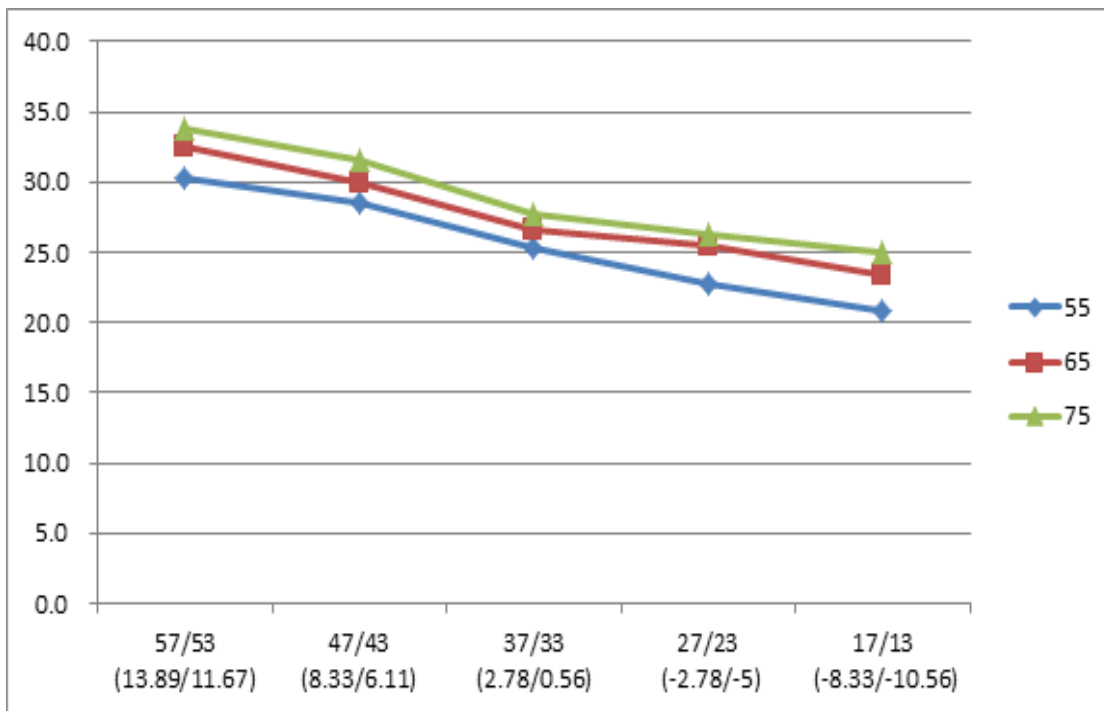


**Fig. 46 – Cooling Chart**

**Pressure on Service Port (Cont)**

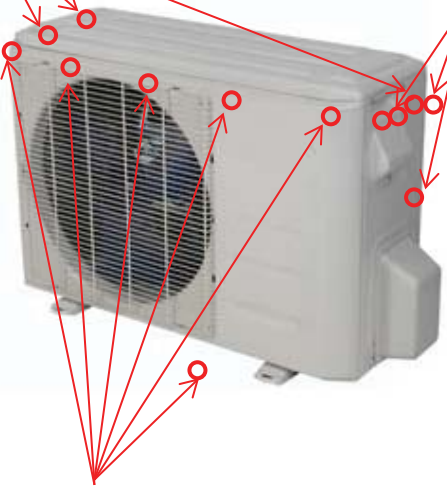
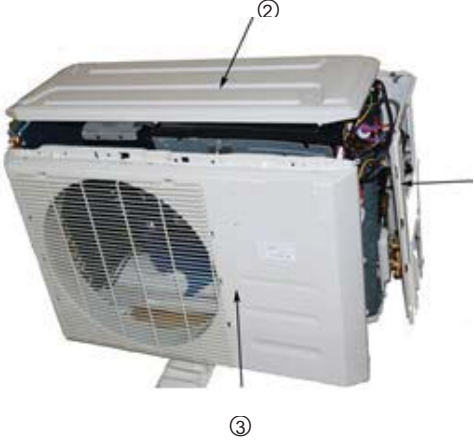
**Table 19—Heating Chart**

°F (°C)	ODT/IDT	57/53 (13.89/11.67)	47/43 (8.33/6.11)	37/33 (2.78/0.56)	27/23 (-2.78/-5)	17/13 (-8.33/-10.56)
BAR	55	30.3	28.5	25.3	22.8	20.8
BAR	65	32.5	30.0	26.6	25.4	23.3
BAR	75	33.8	31.5	27.8	26.3	24.9
°F (°C)	ODT/IDT	57/53 (13.89/11.67)	47/43 (8.33/6.11)	37/33 (2.78/0.56)	27/23 (-2.78/-5)	17/13 (-8.33/-10.56)
PSI	55	439	413	367	330	302
PSI	65	471	435	386	368	339
PSI	75	489	457	403	381	362
°F (°C)	ODT/IDT	57/53 (13.89/11.67)	47/43 (8.33/6.11)	37/33 (2.78/0.56)	27/23 (-2.78/-5)	17/13 (-8.33/-10.56)
MPA	55	3.03	2.85	2.53	2.28	2.08
MPA	65	3.25	3.00	2.66	2.54	2.33
MPA	75	3.38	3.15	2.78	2.63	2.49

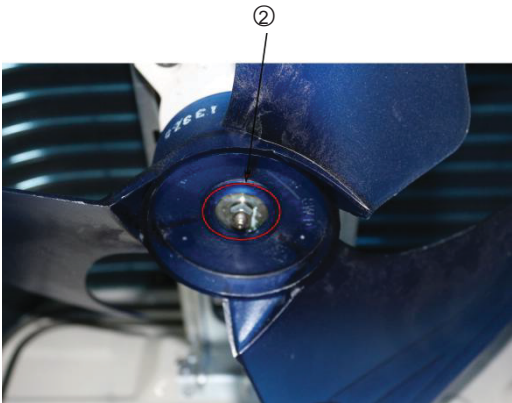
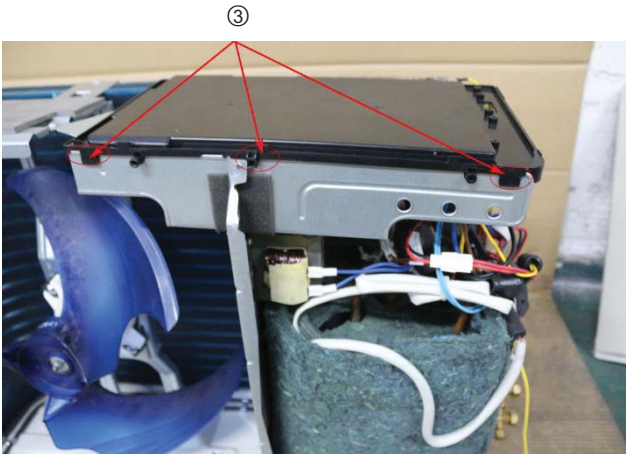
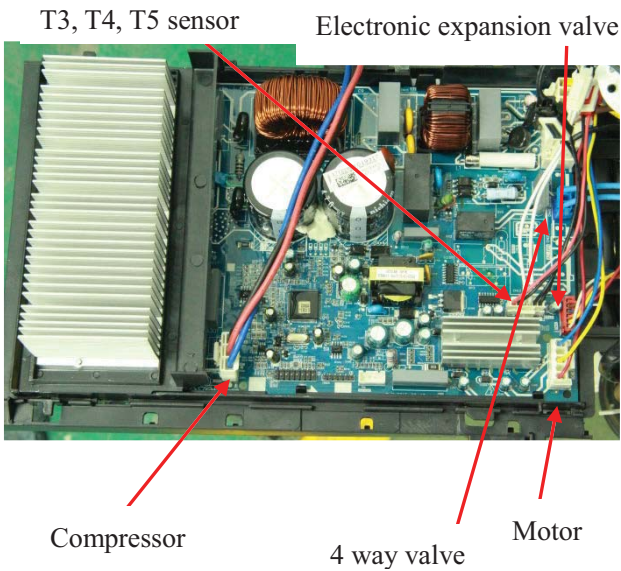


**Fig. 47 – Heating Chart**

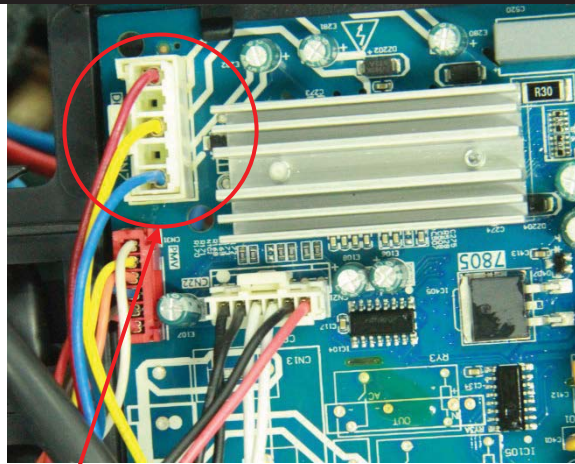
# DISASSEMBLY INSTRUCTIONS SIZES 12K (115V)

1	Panel plate	<p>How to remove the panel plate.</p> <ol style="list-style-type: none"> <li>1. Stop the air conditioner and turn "OFF" the power breaker.</li> <li>2. Remove the big handle first, and then remove the top cover (3 screws).</li> <li>3. Remove the front panel screws (7).</li> <li>4. Remove the right side panel screws (11).</li> </ol>	<p>Top panel screws (3), 1 screws is under the big handle</p>  <p>Big handle (3 screws)</p> <p>Front panel screws (7)</p> 
---	-------------	--	---

## DISASSEMBLY INSTRUCTIONS SIZES 12K (115V) (CONT)

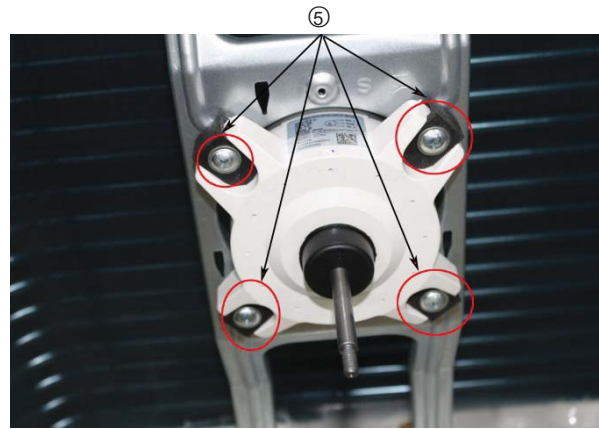
<p>2</p>	<p>Fan assembly</p>	<p>How to remove the fan assembly.</p> <ol style="list-style-type: none"> <li>1) Remove the nut securing the fan, and remove the fan.</li>   <li>2) After removing the top cover, release the hooks and open the electronic control box cover.</li>   <li>3) Disconnect the fan motor connector from the electronic control board.</li> </ol>	  
----------	---------------------	---	---

# DISASSEMBLY INSTRUCTIONS SIZES 12K (115V) (CONT)

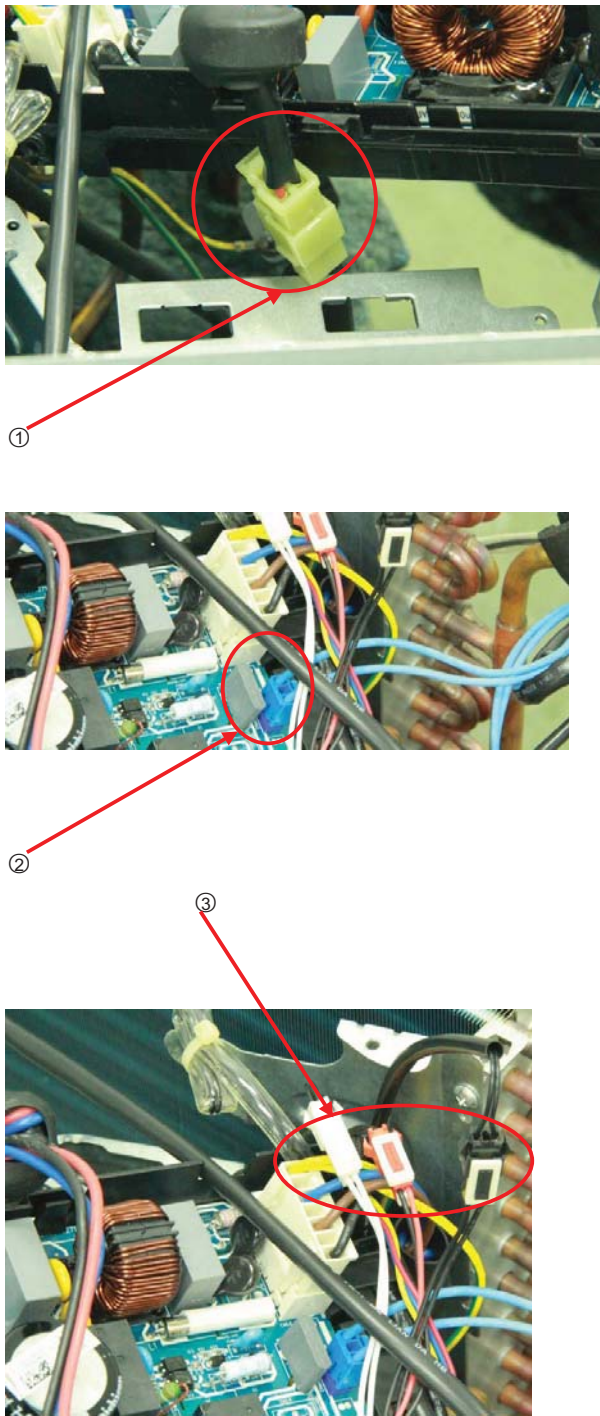


- 4) Remove the fan motor screws (4) then remove the motor.

④



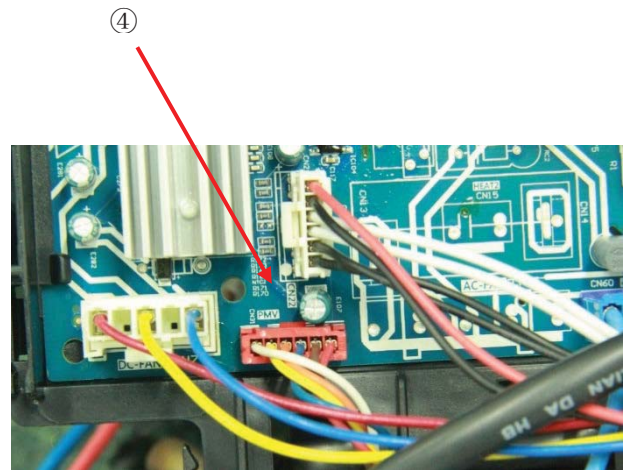
## DISASSEMBLY INSTRUCTIONS SIZES 12K (115V) (CONT)

3	Electrical parts	<p>How to remove the electrical parts.</p> <ol style="list-style-type: none"><li>1) After you complete the steps in item 1 and 2, remove the compressor connector.</li><li>2) Pull out the two blue wires connected to the four way valve.</li><li>3) Pull out connectors of the condenser coil temp. sensor (T3), outdoor ambient temp. sensor (T4) and discharge temp. sensor (T5).</li></ol>	
---	------------------	---	---



## DISASSEMBLY INSTRUCTIONS SIZES 12K (115V) (CONT)

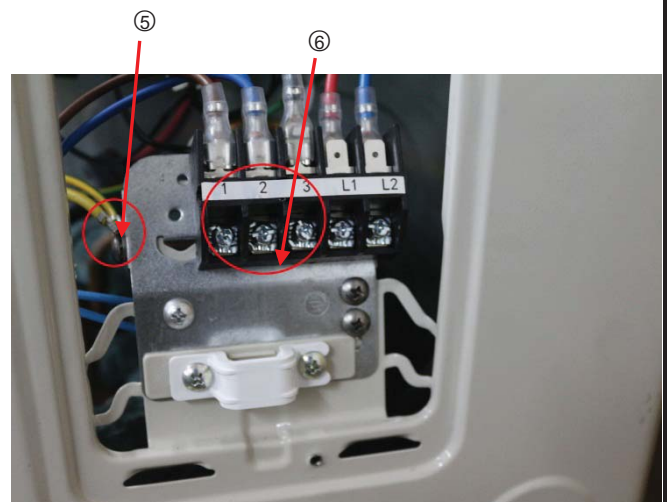
4) Disconnect the electronic expansion valve wire from the control board.



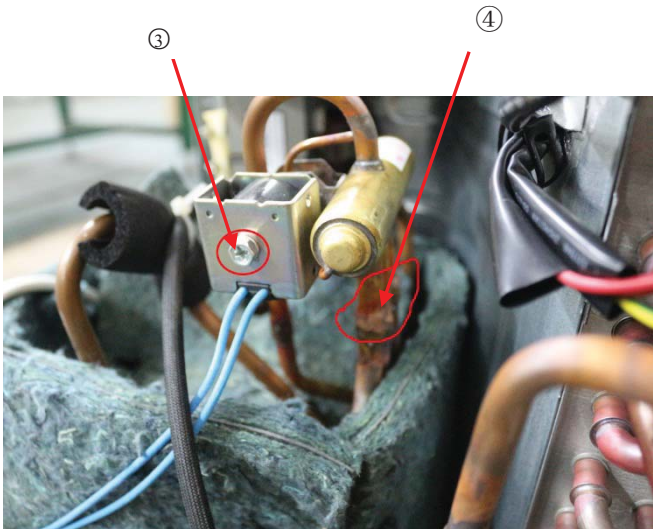
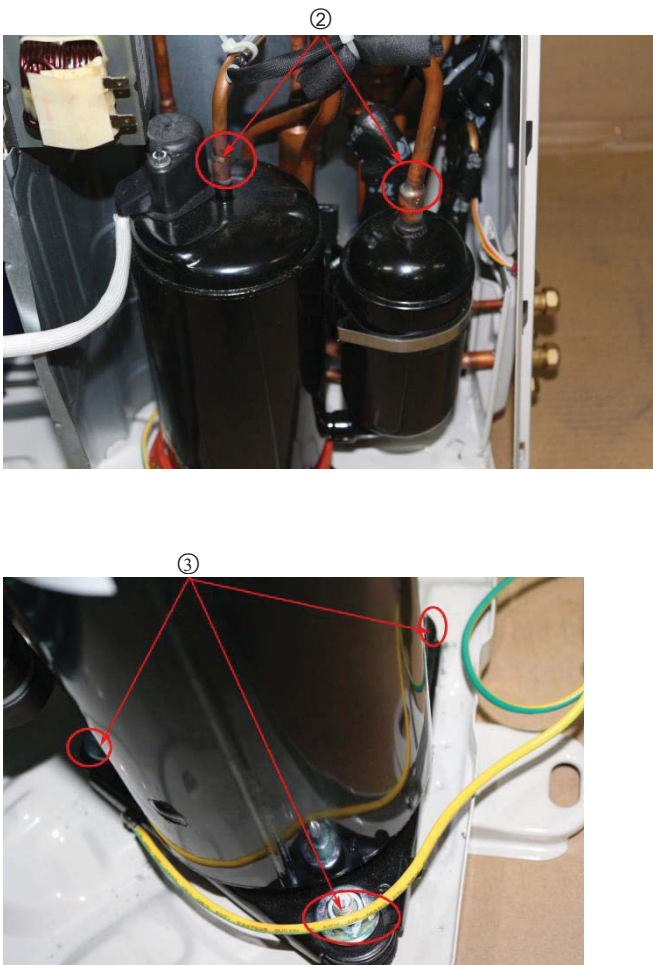
5) Remove the ground wires.

6) Remove the wires (1,2,3).

7) Remove the electronic control box.

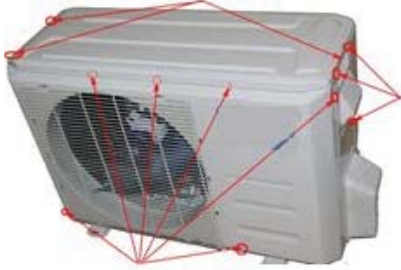
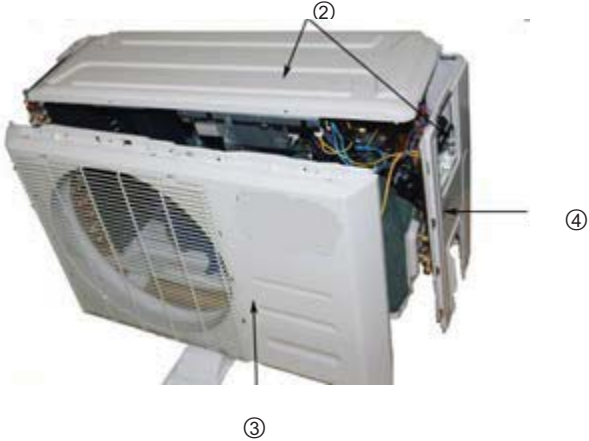


## DISASSEMBLY INSTRUCTIONS SIZES 12K (115V) (CONT)

4	Four-way valve	<p>How to remove the four-way valve.</p> <ol style="list-style-type: none"> <li>1) Perform the work of sections 1 and 3.</li> <li>2) Recover refrigerant from the refrigerant circuit.</li> <li>3) Remove the coil screw then remove the coil.</li> <li>4) Detach the welded parts of the four-way valve and pipe.</li> <li>5) Remove the four-way valve assembly.</li> </ol>	<p>The picture of four-way valve may be different from your actual valve.</p> 
5	Compressor	<p>How to remove the compressor.</p> <ol style="list-style-type: none"> <li>1) Complete the work of sections 1 and 3.</li> </ol> <p>Recover the refrigerant from the refrigerant circuit.</p> <ol style="list-style-type: none"> <li>2) Remove the discharge and suction pipes with a burner.</li> <li>3) Remove the hex nuts and washers securing the compressor on the bottom plate.</li> <li>4) Lift the compressor from the base pan assembly.</li> </ol>	

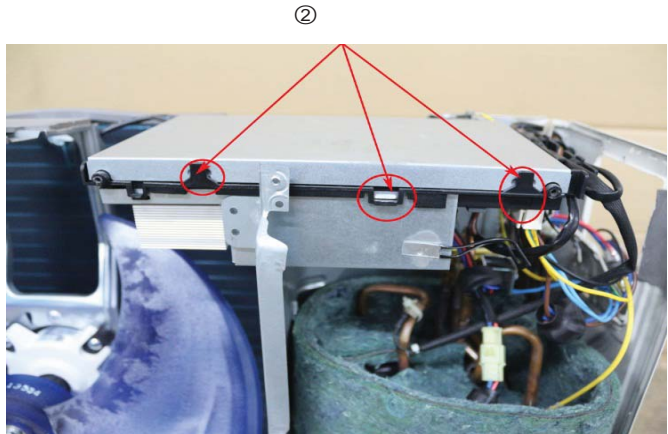
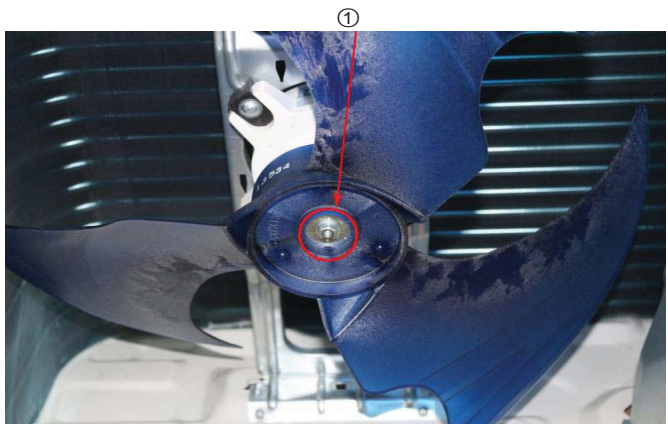


# DISASSEMBLY INSTRUCTIONS SIZES 9–12K (208–230V)

No.	Part name	Procedures	Remarks
1	Panel plate	<p>How to remove the panel plate.</p> <p>1) Stop the air conditioner and turn “OFF” the power breaker.</p> <p>2) Remove the big handle first, then remove the top panel (3 screws).</p> <p>3) Remove the front panel screws (6).</p> <p>4) Remove the right side panel screws (8).</p>	<p>Top panel screws (3 screws, 1 screw is under the big handle)</p>  <p>Big Handler screws (3)</p> <p>Front panel screws (6)</p> 

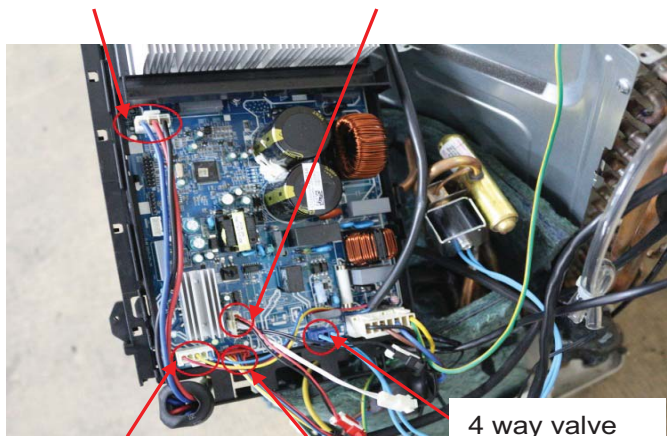
# DISASSEMBLY INSTRUCTIONS SIZES 9–12K (208–230V) (CONT)

2	Fan assembly	<p>How to remove the fan assembly.</p> <p>1) After removing the panel plate using section 1, remove the hex nut securing the fan then remove the fan.</p> <p>2) Release the hooks and open the electronic control box cover.</p>
---	--------------	--



Compressor

T3, T4, T5 sensor

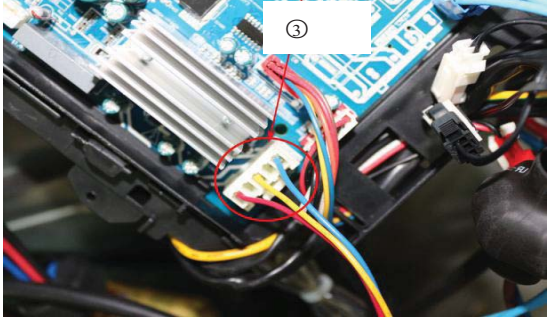
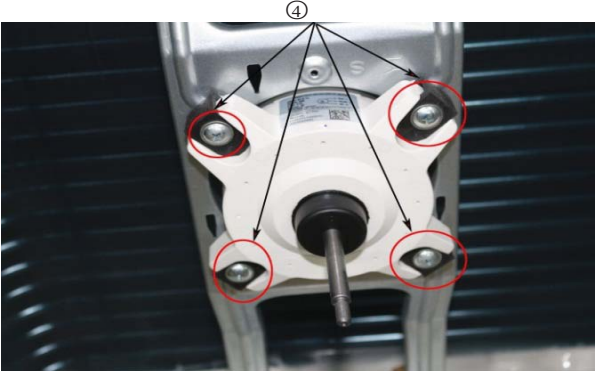

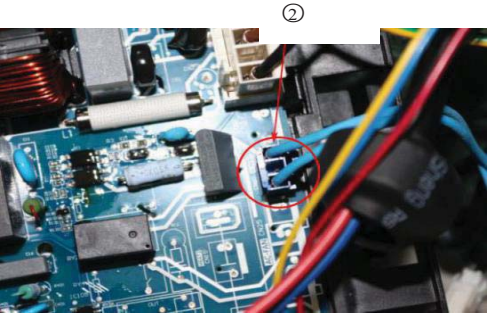



Motor

Electronic expansion valve

4 way valve

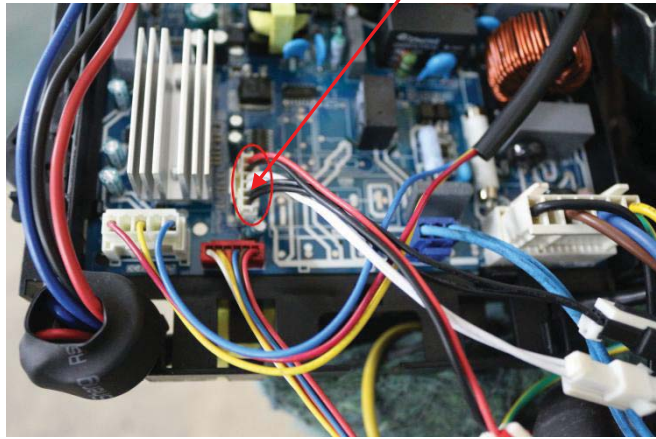
# DISASSEMBLY INSTRUCTIONS SIZES 9–12K (208–230V) (CONT)

		<p>3) Disconnect the fan motor connector and from the electronic control board.</p> <p>4) Remove the fan motor screws (4). Then remove the fan motor.</p>	 
3	Electrical parts	<p>How to remove the electrical parts.</p> <p>1) After completing the work in sections 1 and 2, remove the compressor connectors.</p> <p>2) Pull out the two blue wires connected with the four way valve.</p>	  

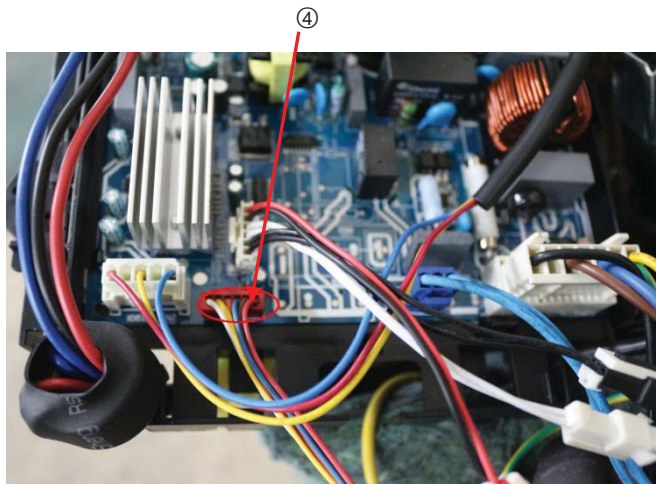


## DISASSEMBLY INSTRUCTIONS SIZES 9–12K (208–230V) (CONT)

3) Pull out connectors of the condenser coil temp. sensor (T3), outdoor ambient temp. sensor (T4) and discharge temp. sensor (T5).

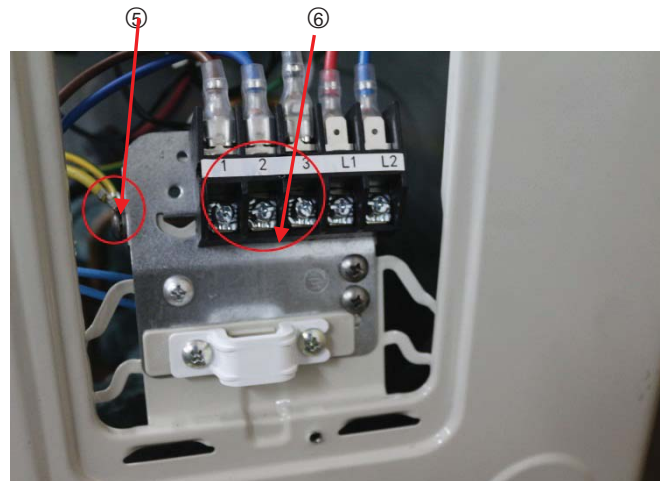


4) Disconnect the electronic expansion valve wire.

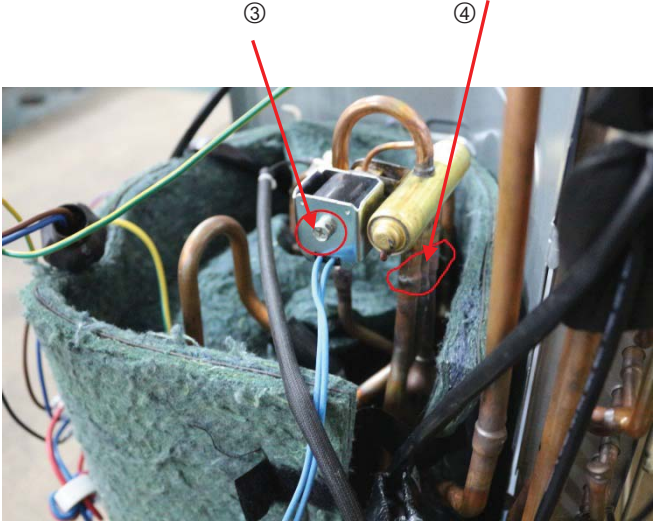

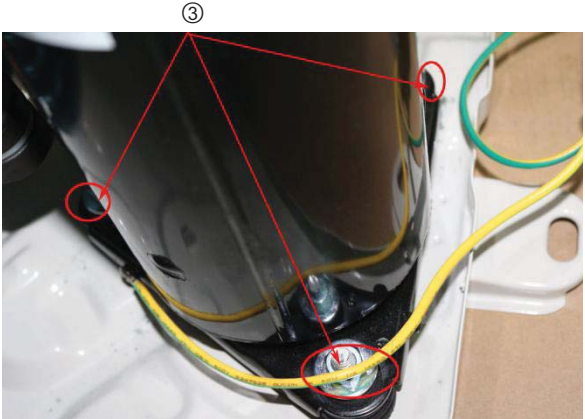


5) Remove the grounding screw.

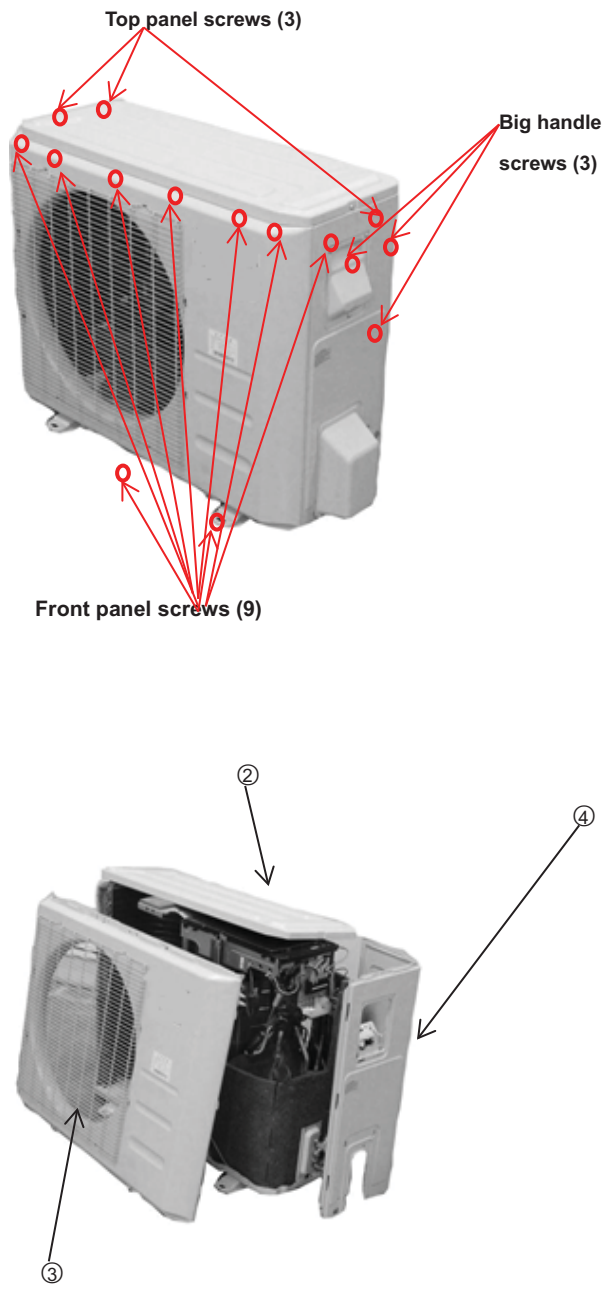
6) Remove the wires (1, 2, 3). Then remove the electronic control box.



## DISASSEMBLY INSTRUCTIONS SIZES 9–12K (208–230V) (CONT)

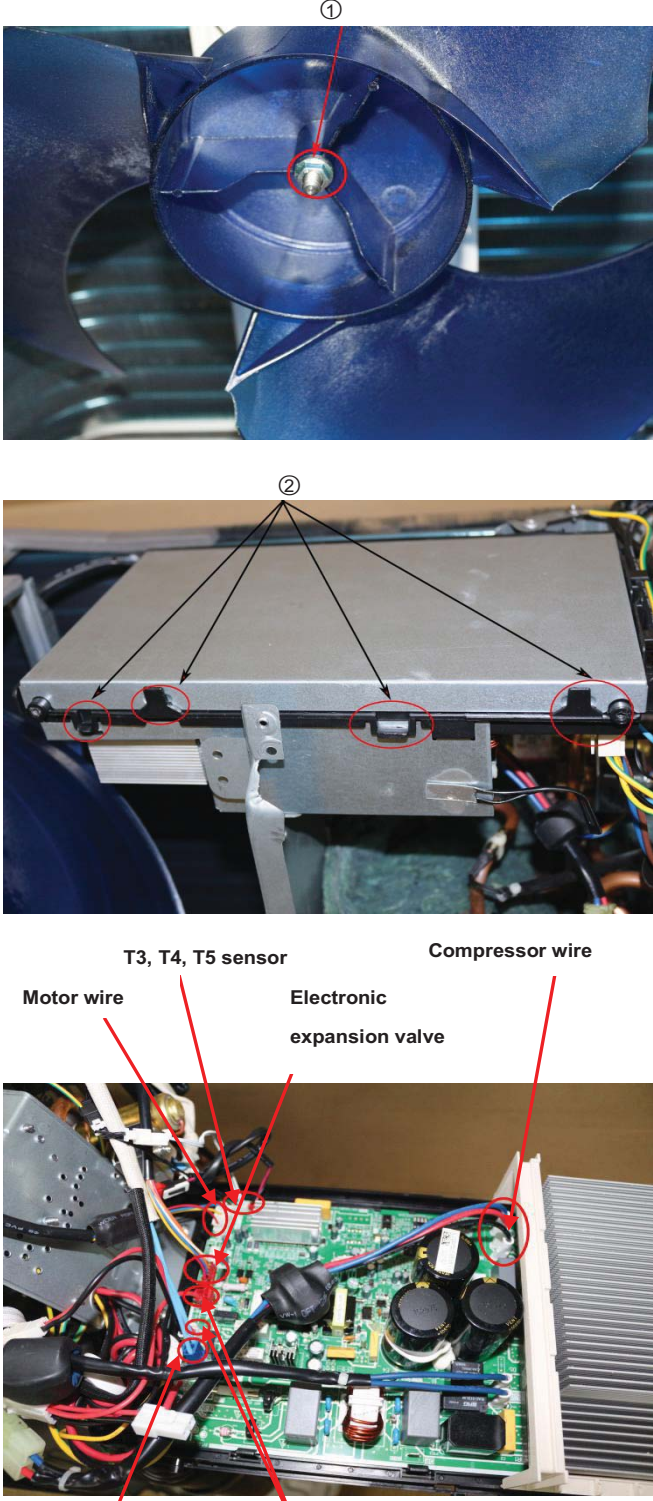
4	Four-way valve	<p>How to remove the four-way valve.</p> <ol style="list-style-type: none"> <li>1) Complete the steps in sections 1, 3.</li> <li>2) Recover refrigerant from the refrigerant circuit.</li> <li>3) Remove the coil screw then remove the coil.</li> <li>4) Detach the welded parts of the four-way valve and pipe.</li> <li>5) Remove the four-way valve assembly.</li> </ol>	<p>The picture of four-way valve may differ from your actual valve.</p> 
5	Compressor	<p>How to remove the compressor.</p> <ol style="list-style-type: none"> <li>1) Complete steps in sections 1, 3.</li> <li>2) Recover refrigerant from the refrigerant circuit.</li> <li>3) Remove the</li> <li>4) discharge and suction pipes with a burner.</li> <li>5) Remove the hex nuts and washers securing the compressor on the bottom plate.</li> <li>6) Lift the compressor from the base pan assembly.</li> </ol>	 

# DISASSEMBLY INSTRUCTIONS SIZES 18K (208–230V)

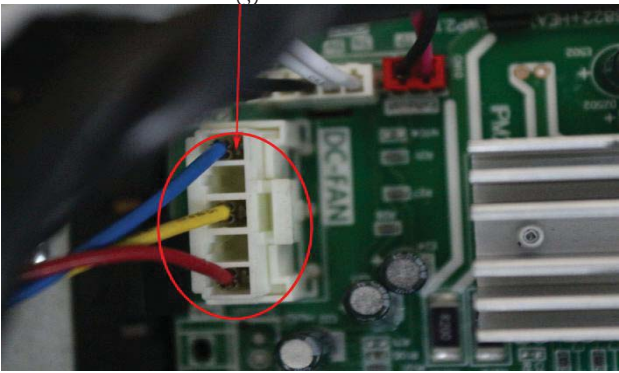
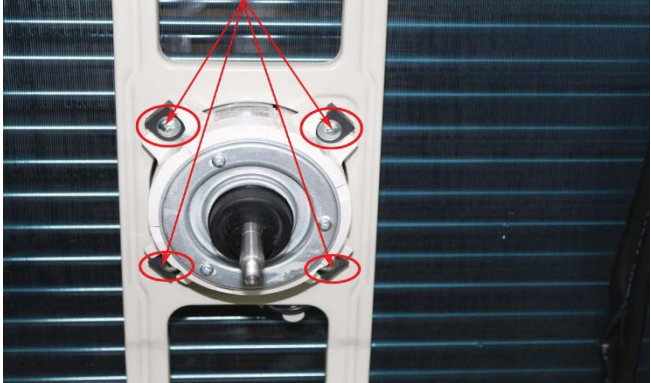
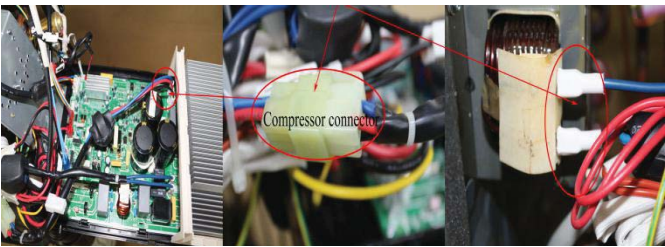
No.	Part name	Procedures	Remarks
1	Panel plate	<p>How to remove the panel plate.</p> <ol style="list-style-type: none"> <li>1) Stop the air conditioner and turn “OFF” the power breaker.</li> <li>2) Remove the top panel screws (3).</li> <li>3) Remove the front panel screws (9).</li> <li>4) Remove the right side panel screws (8).</li> </ol>	 <p>The diagram illustrates the disassembly process in two stages. The top image shows the air conditioner with red arrows pointing to specific screw locations: three screws on the top panel, three screws on the right side labeled 'Big handle screws', and nine screws along the front panel. The bottom image shows the air conditioner with the panel removed, and black arrows pointing to the remaining components: arrow 2 points to the top panel, arrow 3 points to the front panel, and arrow 4 points to the right side panel.</p>



# DISASSEMBLY INSTRUCTIONS SIZES 18K (208–230V) (CONT)

<p>2</p>	<p>Fan assembly</p>	<p>How to remove the fan assembly.</p> <p>1) After removing the panel plate using section 1, remove the hex nut securing the fan then remove the fan.</p> <p>2) After removing the top cover, release the hooks then open the electronic control box cover.</p>	 <p>①</p> <p>②</p> <p>Motor wire      T3, T4, T5 sensor      Compressor wire</p> <p>Electronic expansion valve</p> <p>4 way valve wire      Electric pipe heater and Crankcase electric heater</p>
----------	---------------------	---	---

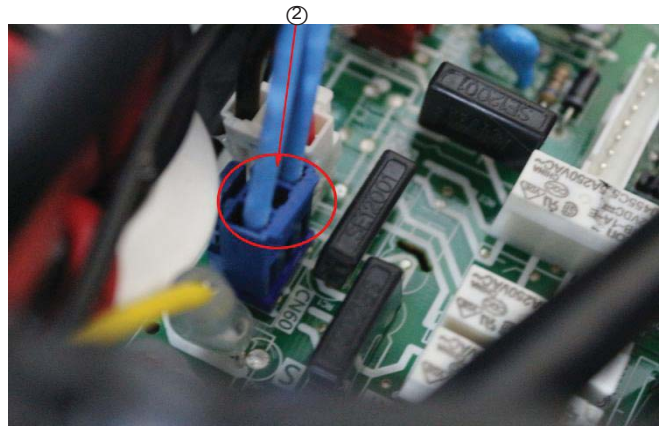
# DISASSEMBLY INSTRUCTIONS SIZES 18K (208–230V) (CONT)

		<p>3) Disconnect the connector for fan motor from the electronic control board.</p> <p>4) Remove the fan motor screws. Then remove the fan motor.</p>	 
3	Electrical parts	<p>How to remove the electrical parts.</p> <p>1) Complete the work of items 1 and 2, then remove the compressor and reactor connectors.</p>	

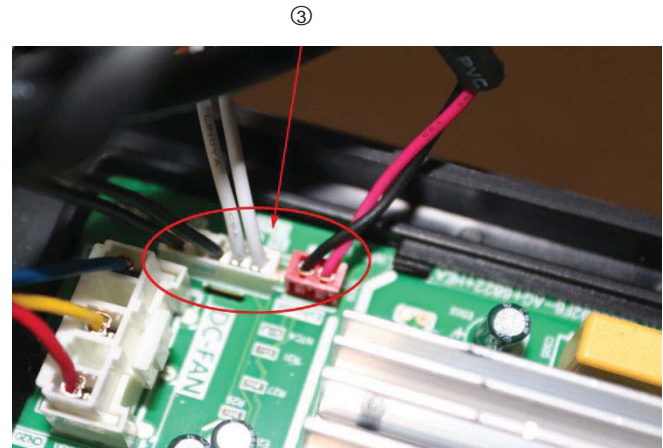


## DISASSEMBLY INSTRUCTIONS SIZES 18K (208–230V) (CONT)

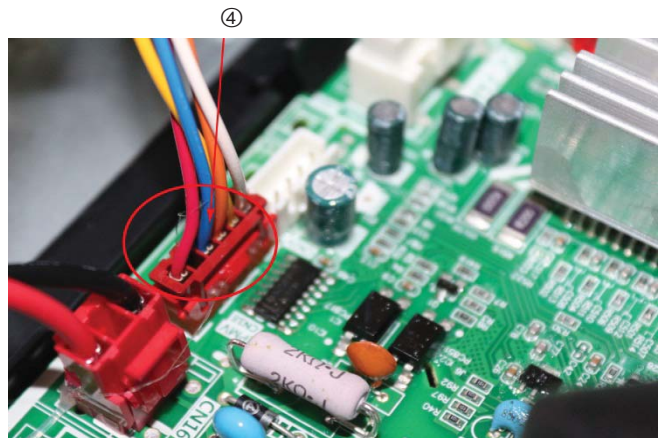
- 2) Pull out the two blue wires connected to the four way valve.



- 3) Remove the connectors of the condenser coil temp. sensor (T3), outdoor ambient temp. sensor (T4) and discharge temp. sensor (T5).

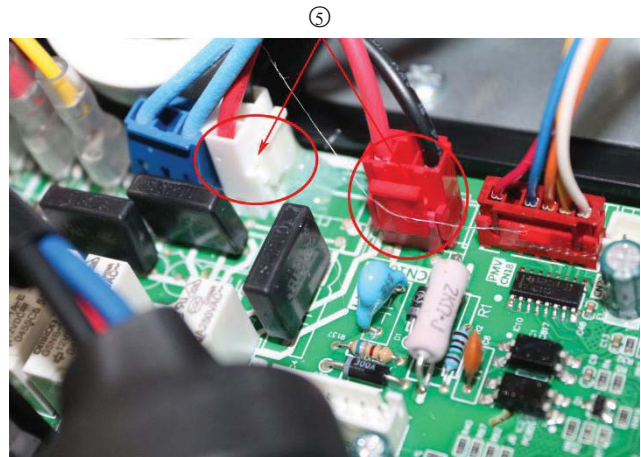


- 4) Disconnect the electronic expansion valve wire.

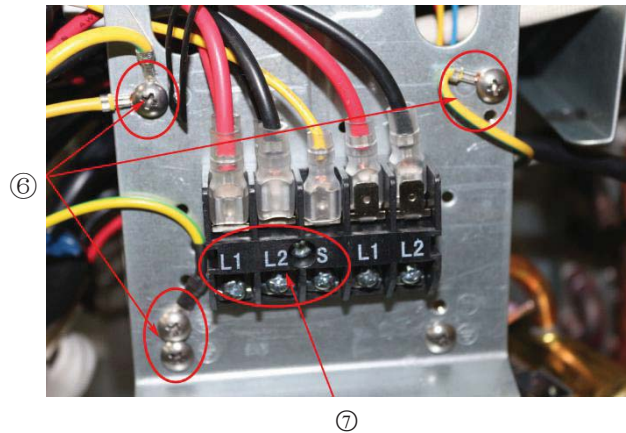


## DISASSEMBLY INSTRUCTIONS SIZES 18K (208–230V) (CONT)

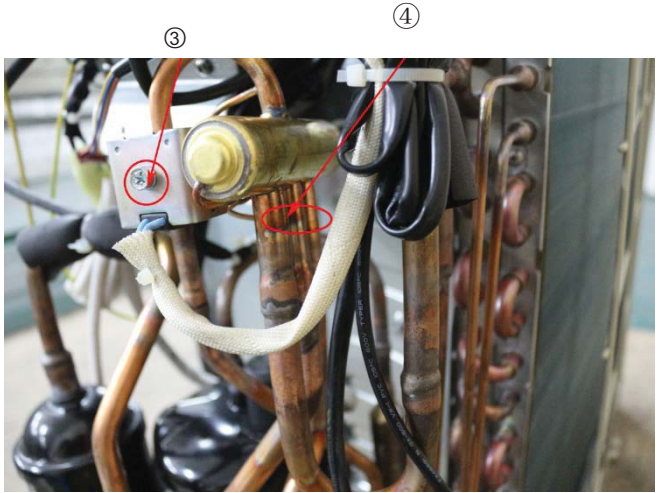

- 5) Remove the electric heaters.



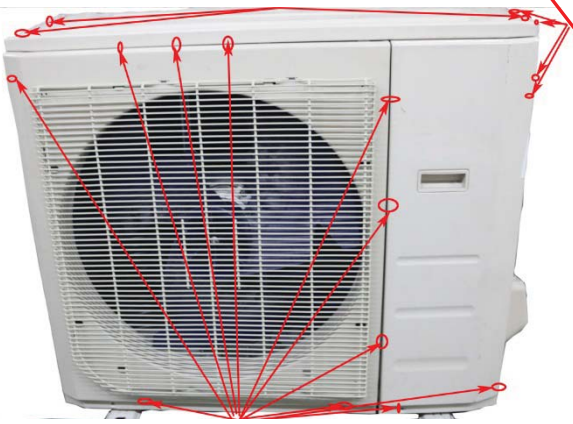
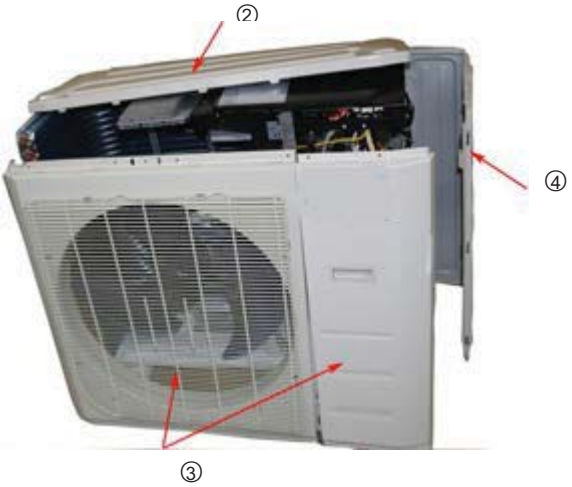
- 6) Remove the grounding screw.
- 7) Remove the wires (1, 2, 3 or L1, L2, S). Then remove the electronic control box.



## DISASSEMBLY INSTRUCTIONS SIZES 18K (208–230V) (CONT)

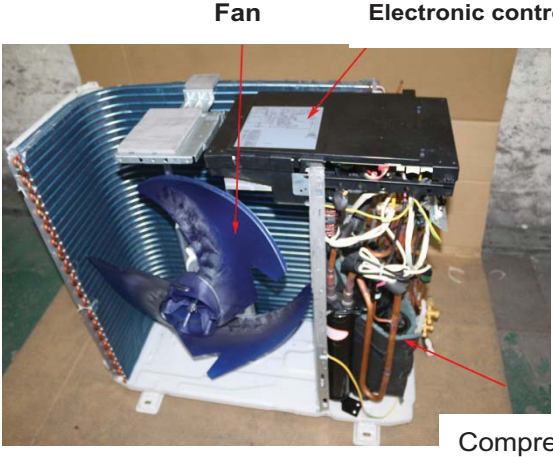

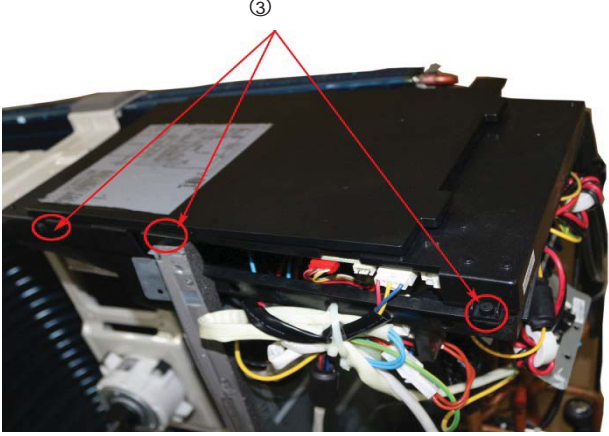
4	Four-way valve	<p>How to remove the four-way valve.</p> <ol style="list-style-type: none"> <li>1) Complete the steps in sections 1, 3.</li> <li>2) Recover refrigerant from the refrigerant circuit.</li> <li>3) Remove the coil screw then remove the coil.</li> <li>4) Detach the welded parts of four-way valve and pipe.</li> <li>5) Remove the four-way valve assembly.</li> </ol>	<p>The picture of four-way valve may differ from your actual valve.</p> 
5	Compressor	<p>How to remove the compressor.</p> <ol style="list-style-type: none"> <li>1) After completing steps in sections 1, 3, recover refrigerant from the refrigerant circuit.</li> <li>2) Remove the discharge and suction pipes with a burner.</li> <li>3) Remove the hex nuts and washers securing the compressor on the bottom plate.</li> <li>5) Lift the compressor from the base pan assembly.</li> </ol>	

# DISASSEMBLY INSTRUCTIONS SIZES 24K (208–230V)

No.	Part name	Procedures	Remarks
1	Panel plate	<p>How to remove the panel plate.</p> <ol style="list-style-type: none"> <li>1) Stop the air conditioner and turn "OFF" the power breaker.</li> <li>2) Remove the big handle first, then remove the top cover (7 screws).</li> <li>3) Remove the front panel screws (11).</li> <li>4) Remove the right side panel screws (13).</li> </ol>	<p style="text-align: right;">Big handle screws (4)</p> <p>Top panel screws (3), 1 screw is under the big handle</p>  <p style="text-align: center;">Front panel screws (11)</p> 



# DISASSEMBLY INSTRUCTIONS SIZES 24K (208–230V) (CONT)

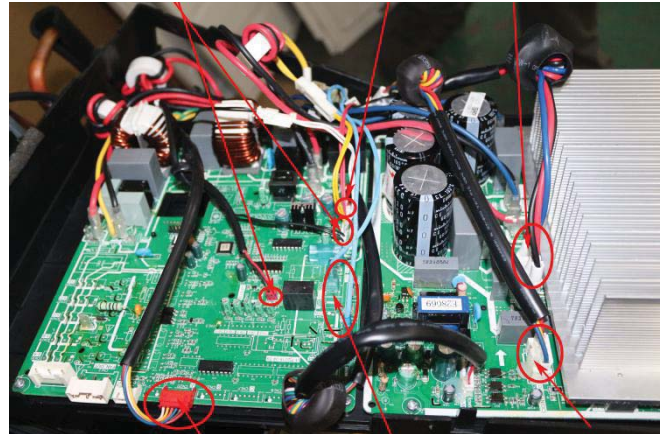
2	Fan assembly	<p>How to remove the fan assembly.</p> <ol style="list-style-type: none"><li>1) Remove the panel plate using the steps in section 1.</li><li>2) Remove the nut securing the fan, then remove the fan.</li><li>3) Release the hooks and remove the screws. Open the electronic control box cover.</li></ol>	 <p>Fan      Electronic control box</p> <p>Compressor</p>  <p>②</p>  <p>③</p>
---	--------------	--	--

# DISASSEMBLY INSTRUCTIONS SIZES 24K (208–230V) (CONT)

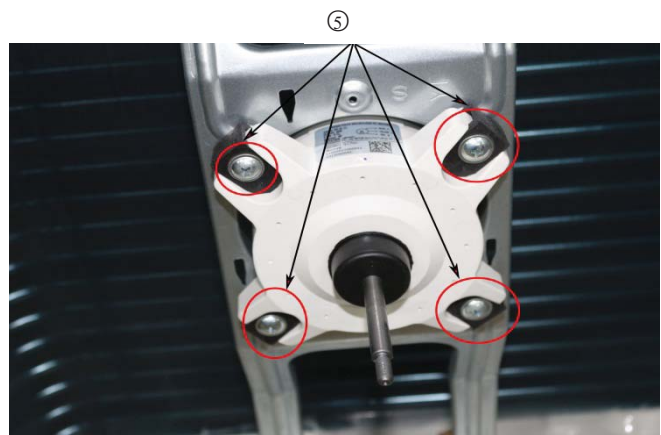
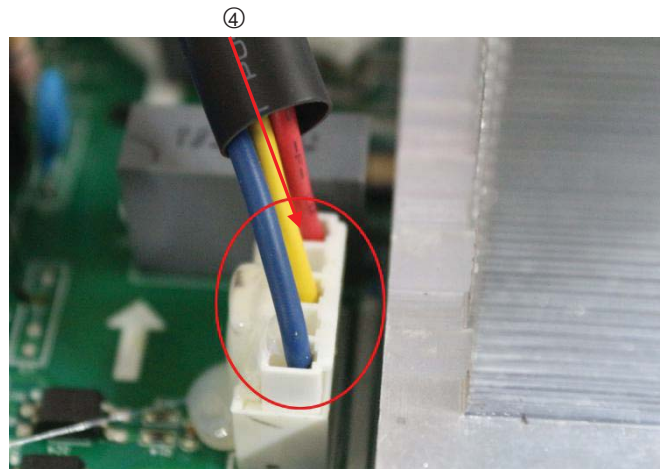
4) Disconnect the fan motor connector from the electronic control board.

5) Remove the fan motor screws (4) of the fan motor, then remove the motor.

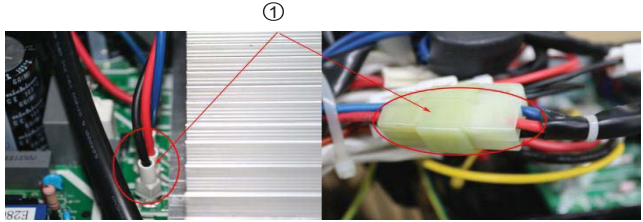
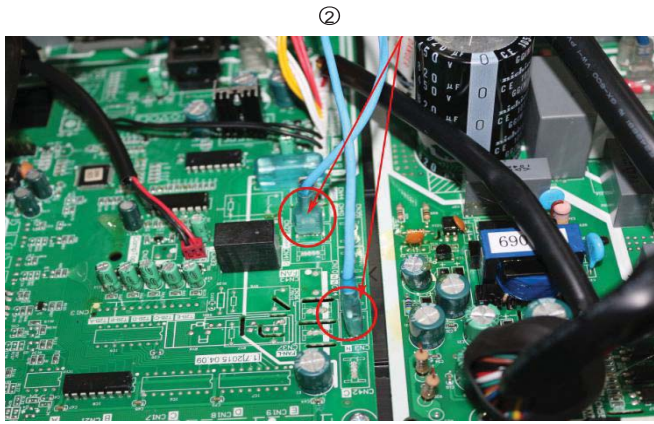
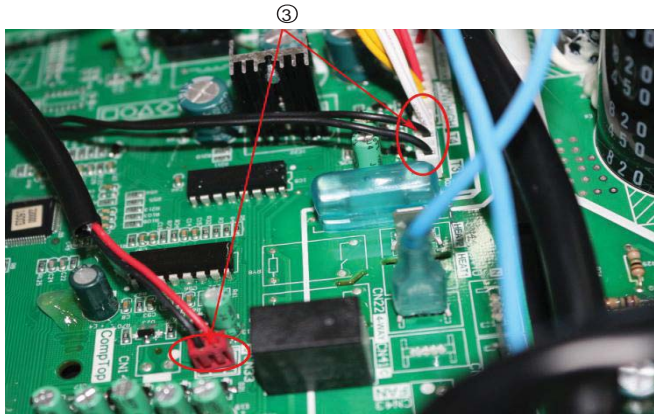
T3, T4, T5, sensor    Pressure switch    Compressor wire



Electronic expansion    4 way valve    Motor wire



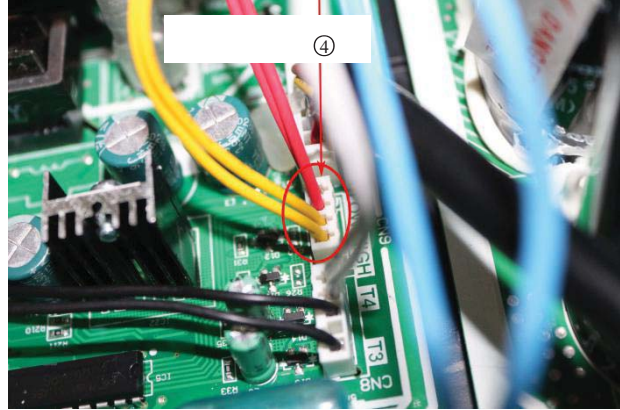
# DISASSEMBLY INSTRUCTIONS SIZES 24K (208–230V) (CONT)

3	Electrical parts	<p>How to remove the electrical parts.</p> <ol style="list-style-type: none"><li>1) After completing the work in sections 1 and 2, remove the compressor connector.</li><li>2) Pull out the two blue wires connected with the four way valve.</li><li>3) Pull out connectors of the condenser coil temp. sensor (T3), outdoor ambient temp. sensor (T4) and discharge temp. sensor (T5).</li></ol>	 <p>①</p>  <p>②</p>  <p>③</p>
---	------------------	--	---

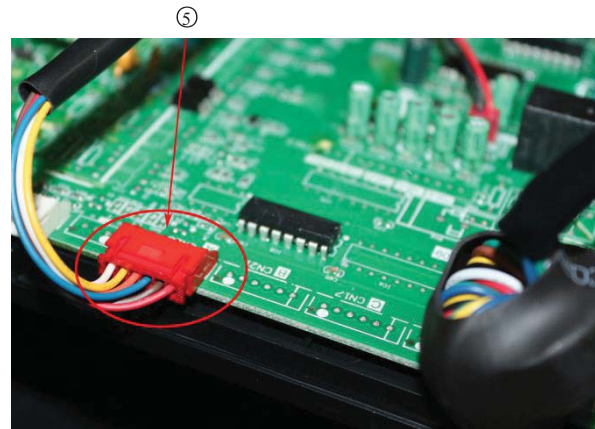


## DISASSEMBLY INSTRUCTIONS SIZES 24K (208–230V) (CONT)

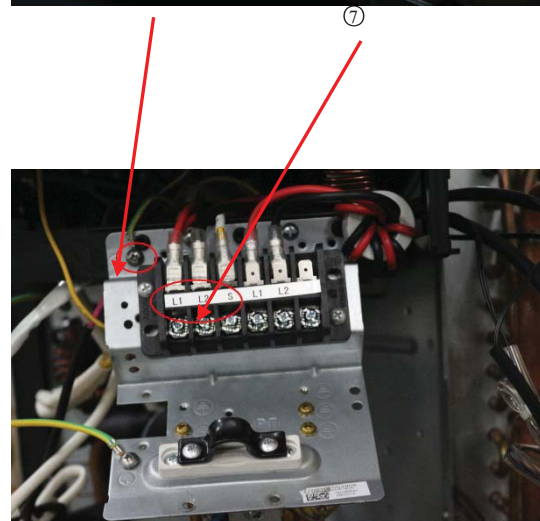
- 4) Disconnect the pressure switch connector.



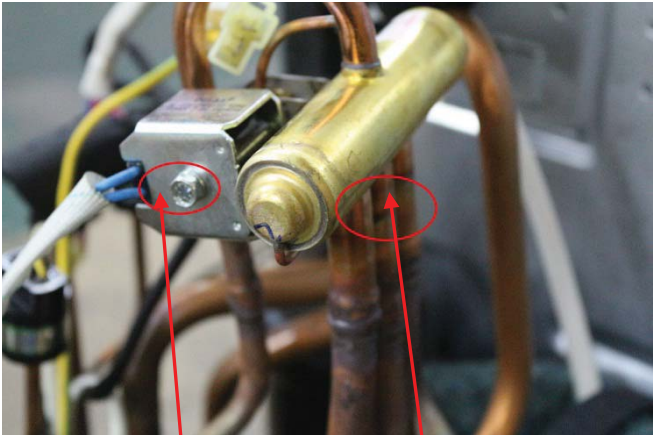
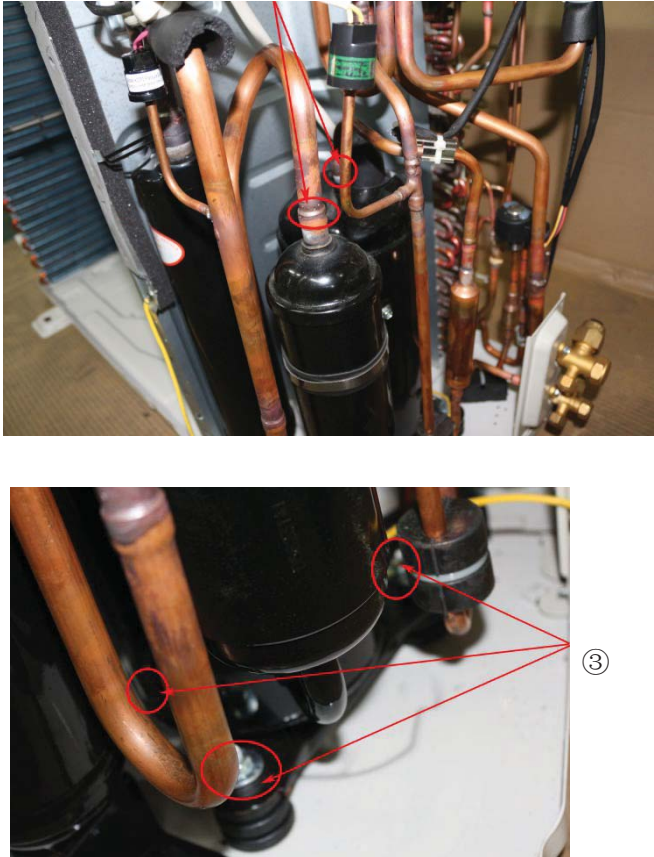
- 5) Disconnect the electronic expansion valve wire from the control board.



- 6) Remove the ground wires.
- 7) Remove the wires (1, 2, 3 or L1, L2, S). Then remove the electronic control box.



## DISASSEMBLY INSTRUCTIONS SIZES 24K (208–230V) (CONT)

4	Four-way valve	<p>How to remove the four-way valve.</p> <ol style="list-style-type: none"> <li>1) Complete the steps in sections 1, 3.</li> <li>2) Recover the refrigerant from the refrigerant circuit.</li> <li>3) Remove the coil screw and then remove the coil.</li> <li>4) Detach the welded parts of four-way valve and pipe.</li> <li>5) Remove the four-way valve assembly.</li> </ol>	<p>The picture of four-way valve may differ from your actual valve.</p>  <p style="text-align: center;">③                      ④</p>
5	Compressor	<p>How to remove the compressor.</p> <ol style="list-style-type: none"> <li>1) Complete steps in sections 1, 3. Recover refrigerant from the refrigerant circuit.</li> <li>2) Remove the discharge and suction pipes with a burner.</li> <li>3) Remove the hex nuts and washers securing the compressor to the bottom plate.</li> <li>4) Lift the compressor from the base pan assembly.</li> </ol>	 <p style="text-align: center;">②</p> <p style="text-align: right;">③</p>

# APPENDIX 1

**Table 20—Temperature Sensor Resistance Value Table for T1, T2, T3, T4 (°C—K)**

°C	°F	K Ohm	°C	°F	K Ohm	°C	°F	K Ohm	°C	°F	K Ohm
-20	-4	115.266	20	68	12.6431	60	140	2.35774	100	212	0.62973
-19	-2	108.146	21	70	12.0561	61	142	2.27249	101	214	0.61148
-18	0	101.517	22	72	11.5	62	144	2.19073	102	216	0.59386
-17	1	96.3423	23	73	10.9731	63	145	2.11241	103	217	0.57683
-16	3	89.5865	24	75	10.4736	64	147	2.03732	104	219	0.56038
-15	5	84.219	25	77	10	65	149	1.96532	105	221	0.54448
-14	7	79.311	26	79	9.55074	66	151	1.89627	106	223	0.52912
-13	9	74.536	27	81	9.12445	67	153	1.83003	107	225	0.51426
-12	10	70.1698	28	82	8.71983	68	154	1.76647	108	226	0.49989
-11	12	66.0898	29	84	8.33566	69	156	1.70547	109	228	0.486
-10	14	62.2756	30	86	7.97078	70	158	1.64691	110	230	0.47256
-9	16	58.7079	31	88	7.62411	71	160	1.59068	111	232	0.45957
-8	18	56.3694	32	90	7.29464	72	162	1.53668	112	234	0.44699
-7	19	52.2438	33	91	6.98142	73	163	1.48481	113	235	0.43482
-6	21	49.3161	34	93	6.68355	74	165	1.43498	114	237	0.42304
-5	23	46.5725	35	95	6.40021	75	167	1.38703	115	239	0.41164
-4	25	44	36	97	6.13059	76	169	1.34105	116	241	0.4006
-3	27	41.5878	37	99	5.87359	77	171	1.29078	117	243	0.38991
-2	28	39.8239	38	100	5.62961	78	172	1.25423	118	244	0.37956
-1	30	37.1988	39	102	5.39689	79	174	1.2133	119	246	0.36954
0	32	35.2024	40	104	5.17519	80	176	1.17393	120	248	0.35982
1	34	33.3269	41	106	4.96392	81	178	1.13604	121	250	0.35042
2	36	31.5635	42	108	4.76253	82	180	1.09958	122	252	0.3413
3	37	29.9058	43	109	4.5705	83	181	1.06448	123	253	0.33246
4	39	28.3459	44	111	4.38736	84	183	1.03069	124	255	0.3239
5	41	26.8778	45	113	4.21263	85	185	0.99815	125	257	0.31559
6	43	25.4954	46	115	4.04589	86	187	0.96681	126	259	0.30754
7	45	24.1932	47	117	3.88673	87	189	0.93662	127	261	0.29974
8	46	22.5662	48	118	3.73476	88	190	0.90753	128	262	0.29216
9	48	21.8094	49	120	3.58962	89	192	0.8795	129	264	0.28482
10	50	20.7184	50	122	3.45097	90	194	0.85248	130	266	0.2777
11	52	19.6891	51	124	3.31847	91	196	0.82643	131	268	0.27078
12	54	18.7177	52	126	3.19183	92	198	0.80132	132	270	0.26408
13	55	17.8005	53	127	3.07075	93	199	0.77709	133	271	0.25757
14	57	16.9341	54	129	2.95896	94	201	0.75373	134	273	0.25125
15	59	16.1156	55	131	2.84421	95	203	0.73119	135	275	0.24512
16	61	15.3418	56	133	2.73823	96	205	0.70944	136	277	0.23916
17	63	14.6181	57	135	2.63682	97	207	0.68844	137	279	0.23338
18	64	13.918	58	136	2.53973	98	208	0.66818	138	280	0.22776
19	66	13.2631	59	138	2.44677	99	210	0.64862	139	282	0.22231

# APPENDIX 2

Table 21—Temperature Sensor Resistance Value Table for T5 (°C—K)

°C	°F	K Ohm	°C	°F	K Ohm	°C	°F	K Ohm	°C	°F	K Ohm
-20	-4	542.7	20	68	68.66	60	140	13.59	100	212	3.702
-19	-2	511.9	21	70	65.62	61	142	13.11	101	214	3.595
-18	0	483	22	72	62.73	62	144	12.65	102	216	3.492
-17	1	455.9	23	73	59.98	63	145	12.21	103	217	3.392
-16	3	430.5	24	75	57.37	64	147	11.79	104	219	3.296
-15	5	406.7	25	77	54.89	65	149	11.38	105	221	3.203
-14	7	384.3	26	79	52.53	66	151	10.99	106	223	3.113
-13	9	363.3	27	81	50.28	67	153	10.61	107	225	3.025
-12	10	343.6	28	82	48.14	68	154	10.25	108	226	2.941
-11	12	325.1	29	84	46.11	69	156	9.902	109	228	2.86
-10	14	307.7	30	86	44.17	70	158	9.569	110	230	2.781
-9	16	291.3	31	88	42.33	71	160	9.248	111	232	2.704
-8	18	275.9	32	90	40.57	72	162	8.94	112	234	2.63
-7	19	261.4	33	91	38.89	73	163	8.643	113	235	2.559
-6	21	247.8	34	93	37.3	74	165	8.358	114	237	2.489
-5	23	234.9	35	95	35.78	75	167	8.084	115	239	2.422
-4	25	222.8	36	97	34.32	76	169	7.82	116	241	2.357
-3	27	211.4	37	99	32.94	77	171	7.566	117	243	2.294
-2	28	200.7	38	100	31.62	78	172	7.321	118	244	2.233
-1	30	190.5	39	102	30.36	79	174	7.086	119	246	2.174
0	32	180.9	40	104	29.15	80	176	6.859	120	248	2.117
1	34	171.9	41	106	28	81	178	6.641	121	250	2.061
2	36	163.3	42	108	26.9	82	180	6.43	122	252	2.007
3	37	155.2	43	109	25.86	83	181	6.228	123	253	1.955
4	39	147.6	44	111	24.85	84	183	6.033	124	255	1.905
5	41	140.4	45	113	23.89	85	185	5.844	125	257	1.856
6	43	133.5	46	115	22.89	86	187	5.663	126	259	1.808
7	45	127.1	47	117	22.1	87	189	5.488	127	261	1.762
8	46	121	48	118	21.26	88	190	5.32	128	262	1.717
9	48	115.2	49	120	20.46	89	192	5.157	129	264	1.674
10	50	109.8	50	122	19.69	90	194	5	130	266	1.632
11	52	104.6	51	124	18.96	91	196	4.849			
12	54	99.69	52	126	18.26	92	198	4.703			
13	55	95.05	53	127	17.58	93	199	4.562			
14	57	90.66	54	129	16.94	94	201	4.426			
15	59	86.49	55	131	16.32	95	203	4.294			
16	61	82.54	56	133	15.73	96	205	4.167			
17	63	78.79	57	135	15.16	97	207	4.045			
18	64	75.24	58	136	14.62	98	208	3.927			
19	66	71.86	59	138	14.09	99	210	3.812			

# APPENDIX 3

Table 22— $\Delta T(^{\circ}F)=9\Delta T(^{\circ}C)/5$

$^{\circ}C$	$^{\circ}F$	$^{\circ}C$	$^{\circ}F$	$^{\circ}C$	$^{\circ}F$	$^{\circ}C$	$^{\circ}F$	$^{\circ}C$	$^{\circ}F$
-5	23	21	69.8	51	123.8	82	179.6	113	235.4
-4	24.8	22	71.6	52	125.6	83	181.4	114	237.2
-3	26.6	23	73.4	53	127.4	84	183.2	115	239
-2	28.4	24	75.2	54	129.2	85	185	116	240.8
-1	30.2	25	77	55	131	86	186.8	117	242.6
0	32	25.5	77.9	56	132.8	87	188.6	118	244.4
0.5	32.9	26	78.8	57	134.6	88	190.4	119	246.2
1	33.8	27	80.6	58	136.4	89	192.2	120	248
1.5	34.7	28	82.4	59	138.2	90	194	121	249.8
2	35.6	29	84.2	60	140	91	195.8	122	251.6
2.5	36.5	30	86	61	141.8	92	197.6	123	253.4
3	37.4	31	87.8	62	143.6	93	199.4	124	255.2
3.5	38.3	32	89.6	63	145.4	94	201.2	125	257
4	39.2	33	91.4	64	147.2	95	203	126	258.8
4.5	40.1	34	93.2	65	149	96	204.8	127	260.6
5	41	35	95	66	150.8	97	206.6	128	262.4
6	42.8	36	96.8	67	152.6	98	208.4	129	264.2
7	44.6	37	98.6	68	154.4	99	210.2	130	266
8	46.4	38	100.4	69	156.2	100	212	131	267.8
9	48.2	39	102.2	70	158	101	213.8	132	269.6
10	50	40	104	71	159.8	102	215.6	133	271.4
11	51.8	41	105.8	72	161.6	103	217.4	134	273.2
12	53.6	42	107.6	73	163.4	104	219.2	135	275
13	55.4	43	109.4	74	165.2	105	221	136	276.8
14	57.2	44	111.2	75	167	106	222.8	137	278.6
15	59	45	113	76	168.8	107	224.6	138	280.4
16	60.8	46	114.8	77	170.6	108	226.4	139	282.2
17	62.6	47	116.6	78	172.4	109	228.2	140	284
18	64.4	48	118.4	79	174.2	110	230	141	285.8
19	66.2	49	120.2	80	176	111	231.8	142	287.6
20	68	50	122	81	177.8	112	233.6	143	289.4